

LISTE DE PIECES

20/06/2016

| | |
|----------------|----------------------------|
| <i>Produit</i> | 537436 - R 2703 G31 37mbar |
| <i>Modèle</i> | R 2700 & R 2800 & R 2900 |
| <i>Marque</i> | RENDAMAX |
| <i>Date</i> | 10/07/2015 |

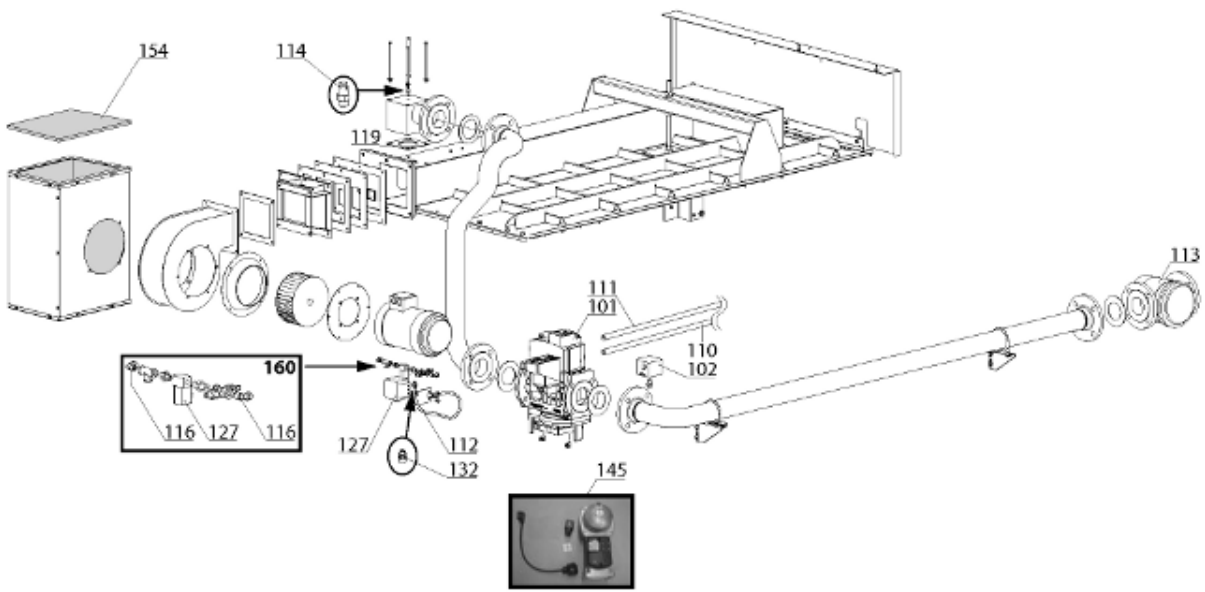

| Table | | PARTIE GAZ | | | | | | | |
|-------|-----------|------------|--|--------------|------------|----------|-------------------|--------------------------|--------|
| Rep. | Référence | ALIAS | Désignation | Remplacé par | Date début | Date fin | Multiple de vente | Tarif Public Unitaire HT | |
| 101 | 64280012 | | VANNE GAZ 340 R01VT2WF-1 | | | | 1 | 1 | 180,90 |
| 102 | 64401601 | | PRESSOSTAT GAZ GW 50 0 --> 50mb | | | | 1 | | 79,00 |
| 110 | 64201304 | | TUBE NOIR D: 4.3x2.9 L: 1M | | | | 1 | | 32,90 |
| 111 | 64201305 | | TUBE BLEU D: 4.3x2.9 L: 1M | | | | 1 | | 32,90 |
| 112 | 64280527 | | TUBE SOUPLE TEFLON D:6/8 L: 2M | | | | 1 | | |
| 113 | 64280123 | | FILTRE GAZ GFK40R10RP1 1/2 | | | | 1 | | 198,50 |
| 114 | 64211101 | | PRISE DE PRESSION 1/8 | | | | 1 | | 2,70 |
| 116 | 64200854 | | RACCORD HAAKS 1/4 8mm | | | | 1 | | 8,40 |
| 116 | 64200855 | | RACCORD COUDE 1/8 8MM | | | | 1 | | 8,10 |
| 119 | 64201306 | | JOINT DE FORME | | | | 1 | | 16,40 |
| 127 | 64200283 | | ELECTROVANNES 230V | | | | 1 | | 173,60 |
| 127 | 64200297 | | ELECTROVANNES 240V | | | | 1 | | 117,60 |
| 132 | 64200853 | | RACCORD DROIT 1/8 M | | | | 1 | | 7,60 |
| 145 | 11002083 | | SERVOMOTEUR SKP15.000E2 CABLE RMK040BS | | | | 1 | | 500,80 |
| 145 | 64201434 | | ACTIONNEUR VANNE GAZ+CABLE SKP25.303E2 | | | | 1 | | 925,80 |
| 154 | 64280125 | | FILTRE A AIR 342X200X15 | | | | 1 | | 10,60 |
| 160 | 17016093 | | PRESSOSTAT AIR | | | | 1 | | |
| 160 | 17016092 | | PRESSOSTAT AIR | | | | 1 | | |



| Table | | GROUPE VENTILATION | | | | | | | |
|--------------|------------------|---------------------------|---|---------------------|-------------------|-----------------|--------------------------|---------------------------------|--|
| <i>Rep.</i> | <i>Référence</i> | <i>ALIAS</i> | <i>Désignation</i> | <i>Remplacé par</i> | <i>Date début</i> | <i>Date fin</i> | <i>Multiple de vente</i> | <i>Tarif Public Unitaire HT</i> | |
| 201 | 64280311 | | MOTEUR VENTILATEUR KMF63 RLDF | | | | 1 | 512,40 | |
| 202 | 64200299 | | TURBINE D'EXTRACTEUR | | | | 1 | 60,70 | |
| 203 | 65000483 | | JOINT DE FORME | | | | 1 | 9,10 | |
| 208 | 17017117 | | PANNEAU RESTRICTION | | | | 1 | | |
| 210 | 65107829 | | COUVERCLE SUPERIEUR | | | | 1 | | |
| 211 | 64202491 | | COUVERCLE & PLAQUE DE POIDS R2909 R3600 | | | | 1 | | |
| 213 | 65000093 | | PRISE D'AIR + FILTRE R2789 | | | | 1 | 555,20 | |
| 214 | 65107832 | | PRISE D'AIR CHAMBRE ETANCHE | | | | 1 | | |

300



R8223937

| Table | | BLOC HYDRAULIQUE | | | | | | | | |
|-------|-----------|------------------|---|--------------|------------|----------|-------------------|--------------|----------|----|
| Rep. | Référence | ALIAS | Désignation | Remplacé par | Date début | Date fin | Multiple de vente | Tarif Public | Unitaire | HT |
| 301 | 64210206 | | CONTROLEUR DEBIT EAU F61-SB9100 | | | | 1 | 223,70 | | |
| 302 | 64211228 | | ROBINET 1/2 (VANNE VIDANGE) | | | | 1 | 36,80 | | |
| 304 | 64211301 | | SOUPAPE SECURITE 3 BARS D:3/4 | | | | 1 | 34,50 | | |
| 304 | 64200354 | | SOUPAPE SECURITE 3 BARS | | | | 1 | 118,10 | | |
| 305 | 64280522 | | SONDE DC (/ KM 628) | | | | 1 | 41,90 | | |
| 306 | 65000459 | | MANOMETRE 0-10 BARS | | | | 1 | 202,40 | | |
| 306 | 64210903 | | MANOMETRE 0-4 BARS | | | | 1 | 32,20 | | |
| 306 | 64200087 | | RACCORD / MANOMETRE 0-->4 bars | | | | 1 | 24,00 | | |
| 306 | 64201240 | | MANOMETRE 0-6 BARS | | | | 1 | 131,50 | | |
| 308 | 64201241 | | PRESSOSTAT SDBRAM (MAX) | | | | 1 | 590,20 | | |
| 309 | 64201242 | | PRESSOSTAT HUBA 625.9978 (MIN) | | | | 1 | 130,70 | | |
| 311 | 64200060 | | GAINÉ DE THERMOSTAT 1/4 7.2 | | | | 1 | 56,00 | | |
| 314 | 64200997 | | JOINT PLAT D:75-38-3 | | | | 1 | 6,90 | | |
| 316 | 64200512 | | JOINT PLAT D:95-58-3 | | | | 1 | 13,60 | | |
| 317 | 12083849 | | VOYANT DE CONTROLE (FLAMME) AVEC MIROIR | | | | 1 | 171,30 | | |
| 318 | 65108160 | | TUYAU DE SIPHON 1/2 | | | | 1 | 86,10 | | |
| 321 | 64280467 | | RACCORD BICONE DROIT 1/8 D.8 | | | | 1 | 14,00 | | |
| 324 | 65107831 | | KIT GARNITURE | | | | 1 | | | |
| 325 | 64200511 | | JOINT 25X5X25000 mm PTFE | | | | 1 | | | |
| 326 | 65108209 | | RACCORD 1/8 D.8 | | | | 1 | 15,40 | | |
| 327 | 65108213 | | TUBE CUIVRE 6X8 mm L:2m | | | | 1 | 149,00 | | |

400



| Table | | RAMPE GAZ | | | | | | | |
|--------------|------------------|------------------|------------------------------|---------------------|-------------------|-----------------|--------------------------|---------------------------------|--|
| <i>Rep.</i> | <i>Référence</i> | <i>ALIAS</i> | <i>Désignation</i> | <i>Remplacé par</i> | <i>Date début</i> | <i>Date fin</i> | <i>Multiple de vente</i> | <i>Tarif Public Unitaire HT</i> | |
| 401 | 65107823 | | PLAQUE PREMELANGEUSE AIR/GAZ | | | | 1 | | |
| 402 | 12037825 | | JOINT DE FORME | | | | 1 | 157,40 | |
| 402 | 64201251 | | JOINT DE FORME | | | | 1 | 46,80 | |
| 403 | 64201251 | | JOINT DE FORME | | | | 1 | 46,80 | |
| 405 | 65108146 | | RESSORT DE PRESSION (10pcs) | | | | 1 | 32,10 | |
| 407 | 12016166 | | JOINT 12X3X20000 mm NEOPR. | | | | 1 | | |
| 409 | 64200511 | | JOINT 25X5X25000 mm PTFE | | | | 1 | | |



| Table | | BRULEUR | | | | | | | |
|--------------|------------------|----------------|----------------------------|---------------------|-------------------|-----------------|--------------------------|---------------------------------|--|
| <i>Rep.</i> | <i>Référence</i> | <i>ALIAS</i> | <i>Désignation</i> | <i>Remplacé par</i> | <i>Date début</i> | <i>Date fin</i> | <i>Multiple de vente</i> | <i>Tarif Public Unitaire HT</i> | |
| 501 | 64201244 | | ECHANGEUR BRULEUR R2802 | | | | 1 | 2 962,70 | |
| 502 | 64202264 | | ELECTRODE ALLUMAGE + JOINT | | | | 1 | 47,50 | |
| 503 | 64201562 | | ELECTRODE IONISATION | | | | 1 | 57,00 | |
| 504 | 64200325 | | JOINT DE FORME | | | | 1 | 4,00 | |
| 505 | 17010022 | | RACCORD M F | | | | 1 | 18,10 | |



5B

| Table | | ECHANGEUR | | | | | | | |
|--------------|------------------|------------------|----------------------------------|---------------------|-------------------|-----------------|--------------------------|---------------------------------|--|
| <i>Rep.</i> | <i>Référence</i> | <i>ALIAS</i> | <i>Désignation</i> | <i>Remplacé par</i> | <i>Date début</i> | <i>Date fin</i> | <i>Multiple de vente</i> | <i>Tarif Public Unitaire HT</i> | |
| 601 | 64201258 | | 1er ECHANGEUR (tubes lisses) | | | | 1 | 2 489,60 | |
| 602 | 64201268 | | ECHANGEUR 2 (tubes ailettes) | | | | 1 | 3 881,10 | |
| 606 | 64200512 | | JOINT PLAT D:95-58-3 | | | | 1 | 13,60 | |
| 607 | 4968707355 | | ISOLANT BLANC 14.64X0.013X0.085m | | | | 1 | 158,30 | |
| 608 | 64200834 | | ISOLANT 420X15X15mm | | | | 1 | 149,80 | |
| 609 | 64200830 | | ISOLANT 20X0.6X0.025 m | | | | 1 | 311,80 | |
| 610 | 4968707491 | | ISOLANT | | | | 1 | | |
| 611 | 64200837 | | ISOLANT | | | | 1 | 171,30 | |
| 612 | 64200815 | | ISOLANT LATERAL L:5m 50X5mm | | | | 1 | 131,80 | |
| 613 | 12039277 | | ISOLANT | | | | 1 | | |

700



| Table | | ECHANGEURS | | | | | | | |
|--------------|------------------|-------------------|---------------------------------------|---------------------|-------------------|-----------------|--------------------------|---------------------------------|--|
| <i>Rep.</i> | <i>Référence</i> | <i>ALIAS</i> | <i>Désignation</i> | <i>Remplacé par</i> | <i>Date début</i> | <i>Date fin</i> | <i>Multiple de vente</i> | <i>Tarif Public Unitaire HT</i> | |
| 701 | 64202276 | | JOINT ISOLATION 25X3mm L:20m (neopr.) | | | | 1 | 188,70 | |
| 702 | 64200436 | | JOINT L:5m | | | | 1 | | |
| 703 | 4148707742 | | COUVERCLE D'INSPECTION COMPLET | | | | 1 | 394,70 | |
| 703 | 6100055 | | INSPECTION BLIND HATCH COMPLETE | | | | 1 | 296,10 | |
| 706 | 64211228 | | ROBINET 1/2 (VANNE VIDANGE) | | | | 1 | 36,80 | |
| 710 | 65107830 | | RECUPERATEUR DE CONDENSAT | | | | 1 | | |
| 712 | 12001810 | | BASE DE CHEMINEE | | | | 1 | | |

800



| Table | | BOITIER ELECTRIQUE | | | | | | | |
|-------|-----------|--------------------|-------------------------------------|--------------|------------|----------|-------------------|--------------------------|--|
| Rep. | Référence | ALIAS | Désignation | Remplacé par | Date début | Date fin | Multiple de vente | Tarif Public Unitaire HT | |
| 801 | 64201884 | | CABLAGE ELECTR. ALLU. | | | | 1 | | |
| 802 | 64210409 | | EMBOUT COUDE ELECTRODE IONISATION | | | | 1 | 24,80 | |
| 803 | 64202438 | | TRANSFORMATEUR 220V / KM628 | | | | 1 | 141,90 | |
| 804 | 64200873 | | VARIATEUR DE FREQUENCE 8201-E | | | | 1 | 884,50 | |
| 805 | 65000230 | | BOITIER DE COMMANDE KM628 | | | | 1 | 777,00 | |
| 805 | 64202435 | | SET CONNECTEURS KM628 | | | | 1 | | |
| 806 | 64201641 | | TRANSFORMATEUR ALLUMAGE+CABLE 2P | | | | 1 | 119,20 | |
| 807 | 64200294 | | INTERRUPTEUR | | | | 1 | 38,10 | |
| 808 | 64202260 | | CONNECTEUR M (KIT) pour 64280310 | | | | 1 | 119,70 | |
| 808 | 64280310 | | CIRCUIT IMPRIME CXE | | | | 1 | 438,80 | |
| 809 | 64201439 | | FILTRE ANTIPARASITE | | | | 1 | 200,50 | |
| 810 | 64201538 | | RELAIS ALAN BRADLEY 100-K09-KF10 | | | | 1 | 89,30 | |
| 810 | 64201539 | | RELAIS 100-K09KF10 & 193-K40 (A&B) | | | | 1 | 260,00 | |
| 811 | 64201300 | | CABLAGE ELECTRODE IONISATION | | | | 1 | 134,90 | |
| 812 | 64280407 | | PRESSOSTAT DIFFERENTIEL | | | | 1 | 109,10 | |
| 813 | 65000251 | | MODULE DE GESTION KKM8 | | | | 1 | 921,50 | |
| 813 | 65000252 | | REGULATEUR DE CHAUF (TYPE E8) | | | | 1 | 533,60 | |
| 813 | 64200788 | | MODULE CLIMATIQUE BM8 | | | | 1 | 560,30 | |
| 814 | 64210410 | | EMBOUT ELECTRODE HT | | | | 1 | 21,20 | |
| 819 | 64300004 | | THERMOSTAT IMIT LS100°C+SONDE L:3m | | | | 1 | 84,40 | |
| 820 | 65108167 | | FERRITE | | | | 1 | 35,60 | |
| 821 | 64211410 | | TRANSFORMATEUR (separateur) | | | | 1 | 190,80 | |
| 823 | 64211221 | | RELAIS 7A/250V-230V | | | | 1 | 16,90 | |
| 824 | 17008295 | | RELAIS TEMPORISE FINDER 85.02.8.240 | | | | 1 | 151,40 | |
| 825 | 64211314 | | SUPPORT RELAIS FINDER | | | | 1 | 13,00 | |
| 826 | 64200564 | | INTERFACE DE COM. COCO 2 | | | | 1 | 139,40 | |

5000

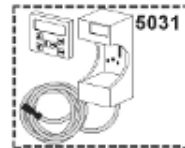
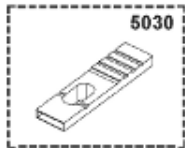
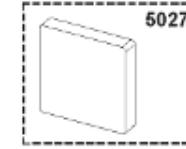
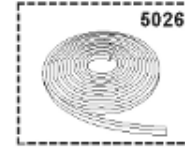
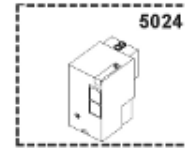
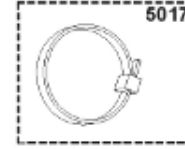
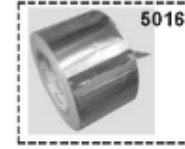
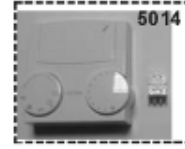
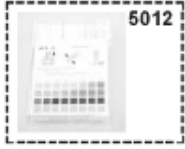

| Table | | OPTIONS | | | | | | | |
|-------|-------------|---------|---------------------------------------|--------------|------------|----------|-------------------|--------------------------|--|
| Rep. | Référence | ALIAS | Désignation | Remplacé par | Date début | Date fin | Multiple de vente | Tarif Public Unitaire HT | |
| 5001 | 64201836 | | SIPHON SEUL FSB | | | | 1 | 74,00 | |
| 5003 | 64921172 | | SONDE SPFS&KFS PLONG | | | | 1 | 63,90 | |
| 5004 | 64921173 | | SONDE VFAS | | | | 1 | 66,80 | |
| 5005 | 64921170 | | SONDE AFS EXT POUR KKM8 OU E8 | | | | 1 | 57,10 | |
| 5010 | 64210199 | | COLLE OMNI VISC | | | | 1 | 68,40 | |
| 5010 | 64210200 | | CARTOUCHE SILICONE-1001U | | | | 1 | 15,40 | |
| 5010 | 64210202 | | COLLE REFRACTAIRE BOITE DE 1KG | | | | 1 | 33,30 | |
| 5010 | 65000352 | | COLLE A1044 | | | | 1 | 158,20 | |
| 5010 | 64200600 | | COLLE A1312 | | | | 1 | 242,70 | |
| 5010 | 64200009 | | SILICONE HAUTE TEMPERATURE | | | | 1 | 61,50 | |
| 5011 | 65001192 | | REPLISSAGE DE GRANULÉS PAR KG | | | | 10 | 8,60 | |
| 5012 | 64200010 | | PAPIER INDICATEUR PH | | | | 1 | 59,50 | |
| 5013 | 64201515 | | CABLAGE SONDE DEPART | | | | 1 | 183,90 | |
| 5014 | 65108162 | | BOITIER CONTROLE FBR2 + SONDE / KM628 | | | | 1 | 97,80 | |
| 5016 | 65108158 | | RUBAN ALU ADHESIF 0.075X50m | | | | 1 | 99,30 | |
| 5017 | 65108166-01 | | TYRAPS 28X5 (Qt:100) | | | | 1 | 126,80 | |
| 5021 | 64200885 | | INTERFACE PC-KM+CAVO | | | | 1 | 638,40 | |
| 5022 | 64202164 | | CABLE COCO E6 R500&R2900 | | | | 1 | | |
| 5023 | 12047923 | | TOILE SILICONE/TRAPPE 0,1X1200X1000mm | | | | 1 | | |
| 5025 | 17016197 | | CONTROLEUR ETANCHEITE TC116W05T | | | | 1 | | |
| 5026 | 17017015 | | JOINT DE FORME L:5M | | | | 1 | | |
| 5027 | 64200889 | | SONDE RFB | | | | 1 | 56,40 | |
| 5028 | 64202276 | | JOINT ISOLATION 25X3mm L:20m (neopr.) | | | | 1 | 188,70 | |
| 5030 | 65000433 | | SHUNT KM628 | | | | 1 | | |