

LISTE DE PIECES

05/07/2016

<i>Produit</i>	3080105 - HYDRA 250 ID RENDAMAX
<i>Modèle</i>	HYDRA
<i>Marque</i>	RENDAMAX
<i>Date</i>	19/06/2013

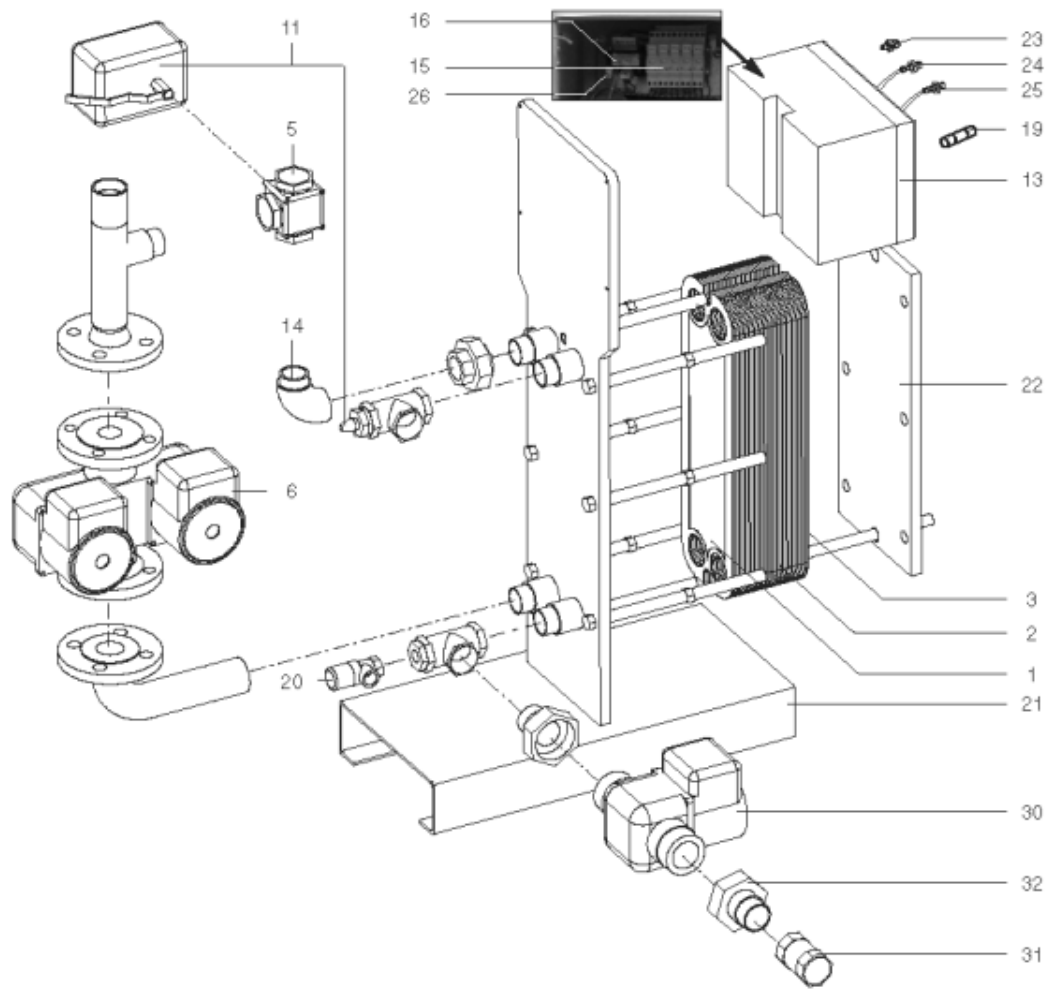

Table		HYDRA 01/2005 > ...							
Rep.	Référence	ALIAS	Désignation	Remplacé par	Date début	Date fin	Multiple de vente	Tarif Public Unitaire HT	
1	61400975		PLAQUE INOX 4 OUVERTURES 45.5X14.2 cm				1	278,60	
2	61400974		PLAQUE INOX INTERMEDIAIRE 45.5X14.2 cm				1	292,50	
3	61400976		PLAQUE INOX PLEINE 45.5X14.2 cm				1	284,00	
5	61400981		VANNE 3 VOIES LAITON DN32 11/4 (ESBE)				1	257,70	
6	61400980		POMPE DOUBLE DE 250 > 600KW				1	2 761,90	
11	61400983		SERVOMOTEUR REGULATEUR (ESBE)				1	2 249,50	
13	61400973		COFFRET ELECTRIQUE 240V HYDRA 1				1	1 381,90	
14	61400982		COUDE UNION PRIMAIRE				1	147,10	
15	60001193		PORTE FUSIBLE				1	19,10	
16	60001655		TRANSFORMATEUR 220/24V 25VA				1	176,60	
19	60001656		FUSIBLE 1A 10X38 AM				1	6,60	
19	60001657		FUSIBLE 2A gG 10X38				1	6,60	
19	60001658		FUSIBLE 500mA 5X20				1	6,60	
20	61400984		SOUPAPE DE SECURITE 7 BARS				1	126,10	
21	61400988		SUPPORT GAUCHE				1	938,90	
22	61400989		SUPPORT DROIT				1	163,50	
23	60000479		BOUTON POUSSOIR				1	35,50	
24	60000480		VOYANT ROUGE				1	57,00	
25	60000481		VOYANT VERT				1	57,00	
26	60001659		RELAIS RCL 424730 220V 2RT				1	19,80	
30	60000066		POMPE SIMPLE BRONZE (G1.5)				1	1 510,80	
31	60000071		CLAPET ANTI-RETOUR				1	141,80	
32	60000072		RACCORD G 1.5				1	192,90	