

LISTE DE PIECES

29/06/2016

<i>Produit</i>	537407 - R 2048 G25 25 mbar
<i>Modèle</i>	R2000
<i>Marque</i>	RENDAMAX
<i>Date</i>	07/01/2008



Table		PARTIE GAZ							
Rep.	Référence	ALIAS	Désignation	Remplacé par	Date début	Date fin	Multiple de vente	Tarif Public Unitaire HT	
101	64201546		VANNE GAZ KS VAS240R/NW				1	379,00	
102	64201433		PRESSOSTAT GAZ 0-->150mb				1	176,60	
102	64401601		PRESSOSTAT GAZ GW 50 0 --> 50mb				1	79,00	
103	64200568		JOINT DE FORME D:78-60-2				1	16,40	
104	64201548		VANNE GAZ KS VAS240R/NWSL				1	679,50	
106	64300702		SERVOMOTEUR REGULATEUR SKP 25.001E2				1	1 056,80	
106	64200092		VALVE GAZ SKP25 CONV. KIT R18/R2000				1	1 056,80	
107	64900005		REGULATEUR PRESSION GBF 25 RO2				1	228,10	
108	64211210		REGULATEUR PRESSION RV 12 M				1	63,90	
109	65000265		ELECTROVANNE VEILLEUSE+CABLE				1	230,45	
110	64211227		RACCORD BICONE COUDE 1/4 D.6				1	17,20	
112	64211224		RACCORD BICONE DROIT 1/8 D.6				1	6,60	
115	64211101		PRISE DE PRESSION 1/8				1	2,70	
116	12013460		JOINT 1 1/2 44x32				1	2,30	
117	64200850		RACCORD				1	10,00	
119	64200846		RACCORD T 1/8				1	12,80	
124	64600106		SERVOMOTEUR REGULATEUR 3 VITESSES				1	895,60	
138	64901001		REGULATEUR GAZ MADAS FC 04 1300 - DN25				1	216,60	

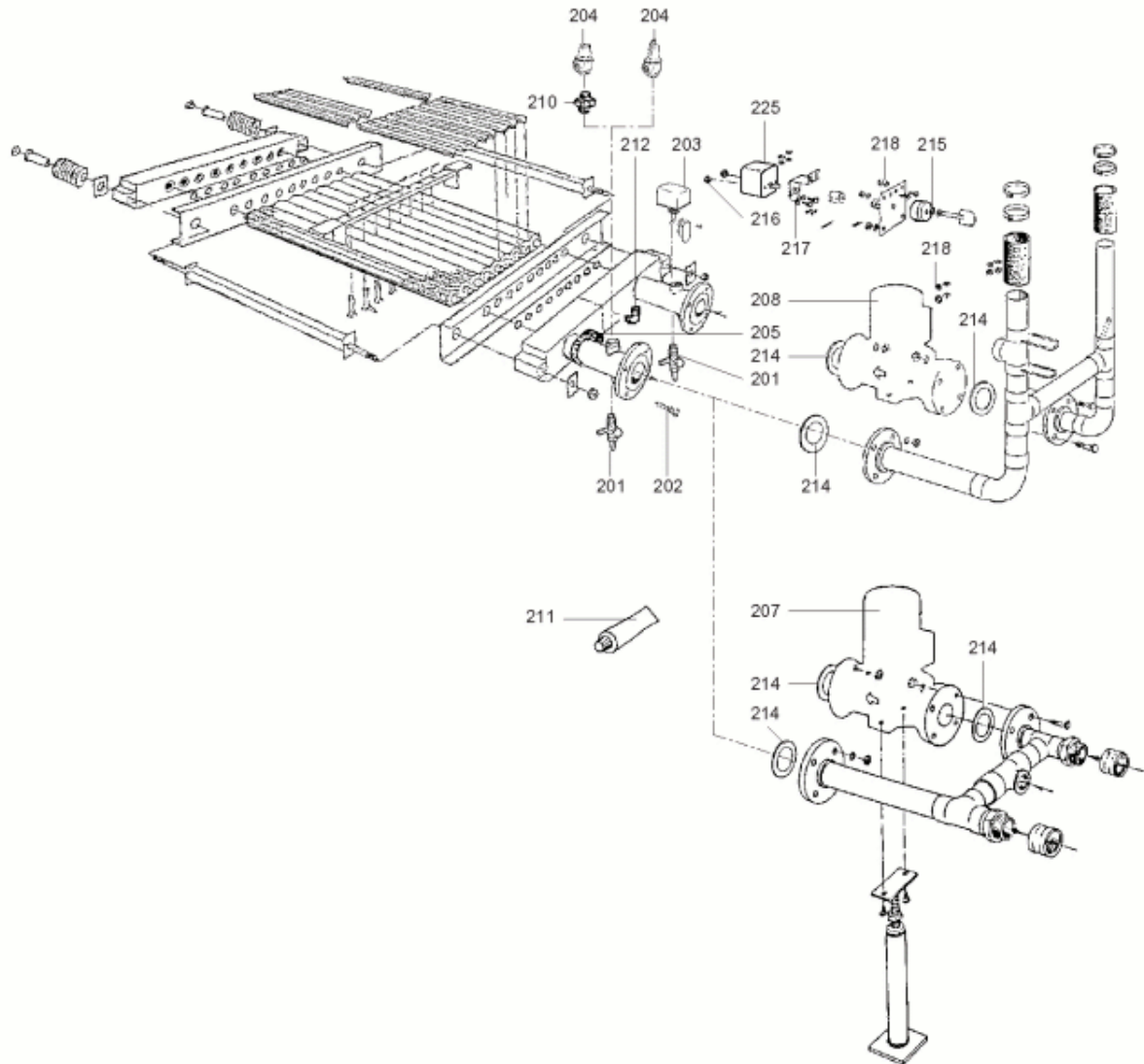

Table		BLOC HYDRAULIQUE							
Rep.	Référence	ALIAS	Désignation	Remplacé par	Date début	Date fin	Multiple de vente	Tarif Public Unitaire HT	
201	64211228		ROBINET 1/2 (VANNE VIDANGE)				1	36,80	
202	64200061		GAINÉ THERMOSTAT 1/4 7.2				1	74,80	
203	64210205		CONTROLEUR DEBIT EAU CH 140°C				1	583,10	
203	64210206		CONTROLEUR DEBIT EAU F61-SB9100				1	223,70	
204	64201476		SOUPAPE SECURITE 5BARS TUV 1				1	290,70	
204	64211303		SOUPAPE SECURITE 3 BARS 1 1/4				1	134,20	
204	64211306		SOUPAPE SECURITE 5 BARS 3/4				1	222,70	
204	64211301		SOUPAPE SECURITE 3 BARS D:3/4				1	34,50	
204	64211307		SOUPAPE SECURITE 5 BARS 1				1	321,20	
204	64201475		SOUPAPE SECURITE 5BARS TUV 3/4				1	283,00	
204	64211308		SOUPAPE SECURITE 5 BARS 1 1/4				1	451,30	
204	64211302		SOUPAPE SECURITE 3 BARS D:1				1	73,00	
205	64300902		SONDE DEPART APPLIQUE QAD 22				1	108,70	
207	64201470		POMPE BRONZE				1	2 327,70	
207	64201469		POMPE BRONZE				1	2 290,00	
207	64201481		POMPE				1	1 065,60	
207	64201391		POMPE				1	1 141,20	
207	64201468		POMPE BRONZE				1	2 156,00	
207	64201392		POMPE				1	869,10	
208	64201392		POMPE				1	869,10	
208	64201391		POMPE				1	1 141,20	
211	64200600		COLLE A1312				1	242,70	
212	64211227		RACCORD BICONE COUDE 1/4 D.6				1	17,20	
214	64210811		JOINT PLAT D:100-55-3				1	7,20	
215	64210804		JOINT PLAT D:11.3-7.7-1.8(axe papil gaz)				1	3,50	
225	64600107		SERVOMOTEUR R2000EM				1	865,10	

300



Table		BRULEUR-HABILLAGE								
Rep.	Référence	ALIAS	Désignation	Remplacé par	Date début	Date fin	Multiple de vente	Tarif Public	Unitaire	HT
301	64200537		TUBE ECHANGEUR R2000 (48)				1	176,80		
302	64201676		JOINTS (Pochette)				1	193,80		
303	65107623		COLLECTEUR				1	431,40		
304	17009021		COLLECTEUR DEPART RETOUR CHAUFFAGE				1	1 064,80		
307	65000457		ISOLANT 85 X 13 mm L:14.64m				1	91,70		
309	64201196		SUPPORT VISEUR DE FLAMME R2000				1	85,40		
310	64211209-01		BEC RAMPE BRULEUR RAYPAK (Qt:20)				1	188,50		
311	64211224		RACCORD BICONE DROIT 1/8 D.6				1	6,60		
312	64200846		RACCORD T 1/8				1	12,80		
313	64211205		RAMPE VEILLEUSE+ELECTRODES UNIVERSEL				1	189,40		
314	64200884		ISOLANT / FIL ELECTRODE D'ALLUMAGE L1m				1	6,67		
315	65108214		FIL ALUMINIUM + CONNECTEUR ELECTRODE				1	62,70		
317	64210712-01		INJECTEUR PROP D:1mm (Qt:20)				1	136,50		
317	64200122-01		INJECTEUR GAZ NAT D:1.8mm (Qt:20)				1	139,20		
319	64211508		VITRE VISEUR DE FLAMME				1	64,00		
320	64201446		SUPPORT ECHANGEUR				1	269,70		
321	64201445		SUPPORT DE BRULEUR				1	99,50		
322	64211101		PRISE DE PRESSION 1/8				1	2,70		
325	64200954		VIS H M 5-12				1	0,40		

400



Table		HABILLAGE							
<i>Rep.</i>	<i>Référence</i>	<i>ALIAS</i>	<i>Désignation</i>	<i>Remplacé par</i>	<i>Date début</i>	<i>Date fin</i>	<i>Multiple de vente</i>	<i>Tarif Public Unitaire HT</i>	
403	64201192		PANNEAU AVANT				1	57,10	
404	64201194		PANNEAU COTE AVEC ISOLANT				1	93,50	
411	64200962		VIS DE FIXATION				1	1,40	

500



600



Table		BOITIER ELECTRIQUE-CHASSIS							
Rep.	Référence	ALIAS	Désignation	Remplacé par	Date début	Date fin	Multiple de vente	Tarif Public Unitaire HT	
501	64220079		FILTRE ANTIPARASITE FN670.6.06				1	130,70	
502	64210409		EMBOUT COUDE ELECTRODE IONISATION				1	24,80	
503	64211314		SUPPORT RELAIS FINDER				1	13,00	
505	64201393		REGULATEUR RWF40.010 A97	64202489			1	607,80	
506	64201670		TRANSFORMATEUR D'ALLUMAGE				1	151,90	
508	64211408		THERMOMETRE R2000				1	113,50	
509	64211502		VOYANT ROUGE DEFAUT				1	9,00	
510	64280461		RELAIS DE CIRCULATEUR CA4-5 220V				1	89,30	
511	64210902		MANOMETRE 0-10 BARS R2000				1	48,70	
512	64210708		INTERRUPTEUR M/A				1	15,90	
513	64210201		COMPTEUR HORAIRE 220V H 57				1	76,70	
514	64211410		TRANSFORMATEUR (separateur)				1	190,80	
515	64211221		RELAIS 7A/250V-230V				1	16,90	
515	64211221		RELAIS 7A/250V-230V				1	16,90	
516	64211116		CONNECTEUR 3 POLES / ALLUMAGE				1	19,60	
517	64210210		CABLAGE ELECT. SOUPLE 3X0.75 mm2 (L:10m)				1	149,50	
518	64200860		CONNECTEUR MALE 3 POLES				1	12,90	
520	64200797		COFFRET LFL 1.148				1	647,10	
521	64200867		CONNECTEUR MALE 3 POLES				1	14,60	
522	64200876		CABLAGE L:0.6mm L&G+GIUN				1	32,80	
523	64210207		CABLAGE ELECTR. 30 CONDUCTEURS 5				1	18,50	
524	64200862		CONNECTEUR M + CABLE MOT. L:0.5m				1	34,20	
525	64201467		THERMOSTAT				1	245,70	
526	64210209		CABLAGE ELECTRIQUE SOUPLE 4X1 mm2 (L10m)				1	198,70	
528	64201394		RELAIS HORLOGE				1	266,20	
529	64300004		THERMOSTAT IMIT LS100°C+SONDE L:3m				1	84,40	
530	65000447		HORLOGE JOURNALIER				1	501,10	
531	64200861		CONNECTEUR FEMELLE 4 POLES				1	10,10	
532	64200859		CONNECTEUR FEMELLE 4 POLES				1	24,10	
533	64200869		CABLAGE L:0.5m				1	57,40	
535	64210101		BOUTON DE REARMEMENT R18/R2000				1	6,80	
536	64200954		VIS H M 5-12				1	0,40	
538	64211405		THERMOSTAT DE SECURITE 150°C				1	293,80	
601	64200827		ISOLANT BLANC L:40mm	65000456			1	81,50	
602	64200832		ISOLANT BEIGE 1000X12X15mm				1	53,90	
603	65000457		ISOLANT 85 X 13 mm L:14.64m				1	91,70	
604	64200828		ISOLANT FIBRE BLANC L:470mm E:13				1	36,40	
607	64210500		FIL INOX D:1.5mm				1	7,10	
610	65107689		SET PIERRES D'ISOLATION				1	658,10	
613	64200042		BRIQUE REFRACTAIRE 535X500X60				1	133,70	
616	64200830		ISOLANT 20X0.6X0.025 m				1	311,80	
620	64200962		VIS DE FIXATION				1	1,40	
622	64210202		COLLE REFRACTAIRE BOITE DE 1KG				1	33,30	