

300000404-001-A

**HK 2-
20-25-35-50**

CORPS DE CHAUDIÈRE HK 2 / KESSELKÖRPER HK 2

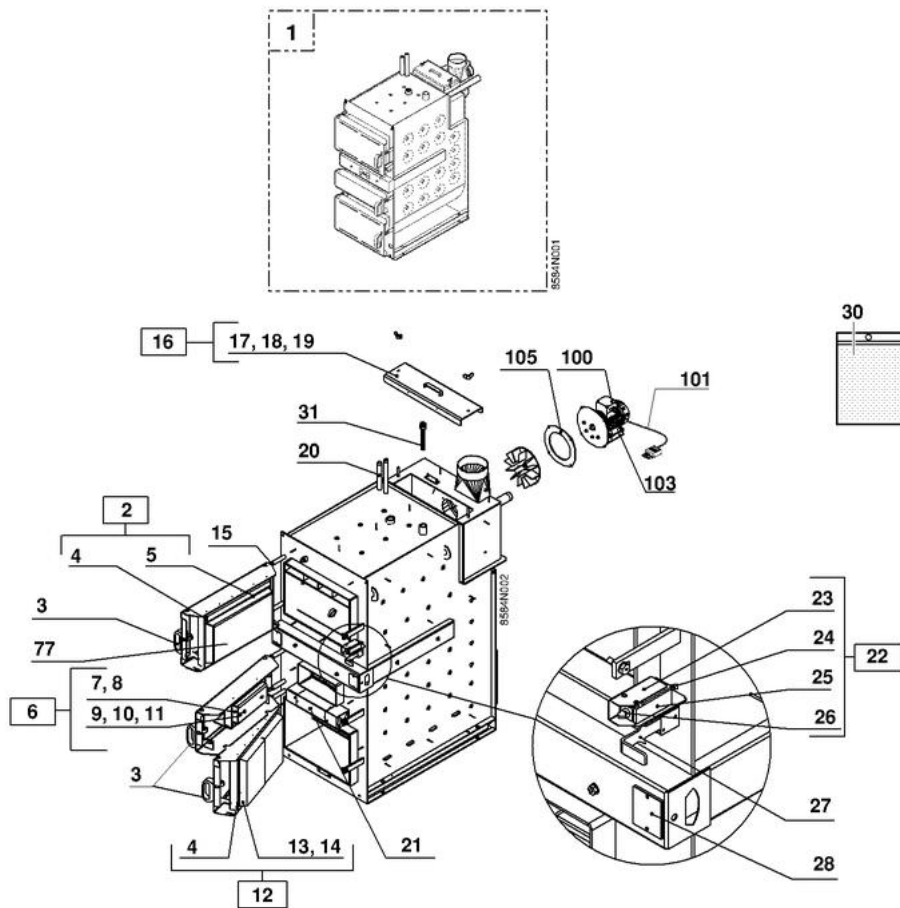

ADD 1/18

Réf.	Référence	Description	Qté	Tarif	Substitut	Tarif Sub.	Remarques
	95317388	CONNECTEUR 4 PLOTS FEM.	1	12,30 €			
	95317384	CONNECTEUR MALE 4PL.WIELANC	1	8,00 €			
1	85847009	CORPS HK2 20KW OUV.G.MK9	1	Nous consulter ...			⊘
1	85847010	CORPS HK2 20KW OUV.D.MK10	1	Nous consulter ...			⊘
1	85847011	CORPS HK2 25KW OUV.G.MK11	1	Nous consulter ...			⊘
1	85847012	CORPS HK2 25KW OUV.D.MK12	1	Nous consulter ...			⊘
1	85847013	CORPS HK2 35KW OUV.G.MK13	1	Nous consulter ...			⊘
1	85847014	CORPS HK2 35KW OUV.D.MK14	1	Nous consulter ...			⊘
1	85847015	CORPS HK2 50KW OUV.G.MK15	1	Nous consulter ...			⊘
1	85847016	CORPS HK2 50KW OUV.D.MK16	1	Nous consulter ...			⊘
2	97930755	PORTE REMPLIS. HK20-50 II (CHAR	1	572,00 €			
2	300000212	PORTE REMPLIS. HK20-50 II (CHAR	1	566,00 €			⊘
3	97930606	POIGNEE VERTE	1	33,40 €			
4	97930756	JOINT D.18 LG.1.60M	1	51,50 €			
5	300000231	JOINT 20 X 25 LG.450	1	44,90 €			
6	97930760	PORTE DALLUMAG.HK20-50II (CHA	1	403,00 €			
6	300000214	PORTE DALLUMAG.HK20-50II (CHA	1	407,00 €			
7	97930677	REFRACTAIRE PORTE DALLUM	1	Nous consulter ...			⊘
8	97930694	ISOLATION PORTE DALLUM.	1	17,30 €			
9	97930676	TOLE ENTREE AIR PRIMAIRE	1	25,90 €			
10	300000217	TOLE PORTE DALLUMAGE	1	55,90 €			
11	97930695	JOINT PORTE DALLUMAGE	1	30,50 €			⊘
12	97930757	PORTE CENDRIER HK20-50 II (CHA	1	441,00 €			
12	300000213	PORTE CENDRIER HK20-50 II (CHA	1	442,00 €			⊘
13	97930758	REFRACTAIRE PORTE CENDR.	1	105,00 €			
14	97930759	ISOL.PORTE CENDR.HK20-50	1	21,90 €			
15	97930737	CHARNIERE PORTE REMP+ALL.	1	19,60 €			
16	97930761	TAMPON RAMONAGE HK20-50II	1	224,00 €			⊘
17	97930762	REFRACT.TAMPON HK20-50II	1	50,20 €			
18	97930763	ISOLATION TAMP. HK20-50II	1	9,75 €			
19	97930650	JOINT PORTE CENDRIER	1	47,40 €			
20	97930778	ECHANGEUR DE SECURITE	1	681,00 €			
21	97930917	PLAQ.NETT.AIR SEC.HK20-35	1	34,50 €			
22	97930698	CONTACTEUR	1	320,00 €			
23	97930775	TOLE PROTECTI. CONTACTEUR	1	31,40 €			
24	97930699	CABLE CONTACTEUR	1	Nous consulter ...			⊘
25	97930776	CONTACTEUR	1	221,00 €			⊘
26	97930777	ROULETTE CONTACTEUR	1		97930698	320,00 €	
27	97930779	VERROU DE SURETE	1	11,90 €			
28	97930780	PLAQ.NETT.AIR PRI.HK20-45	1	25,70 €			
28	97930780	PLAQ.NETT.AIR PRI.HK20-45	1	25,70 €			
28	97930781	PLAQ.NETT.AIR PRI.HK50	1	21,00 €			
30	97930691	SACHET ACCESSOIRES CHAUD.	1	Nous consulter ...			⊘
31	97930373	DOIGT DE GANT	1	29,00 €			
77	97930913	ISOLATION PORTE CHARGEM.	1	Nous consulter ...			⊘
100	300000218	MOTEUR RBO 09/2-71RQ 55W (TAB	1	1092,00 €			
100	300000219	MOTEUR RBO 09/4/2-71R 4- 55W (T.	1	1437,00 €			
101	97930657	CABLE VENTILATEUR	1	56,90 €			
103	97930659	CONDENSATEUR 3µF/450VDB	1	Nous consulter ...			⊘

105	97930661	JOINT BRIDE MOTEUR	1	42,30 €
-----	----------	--------------------	---	---------

HK 2-

20-25-35-50

FOYER / FEUERRAUM

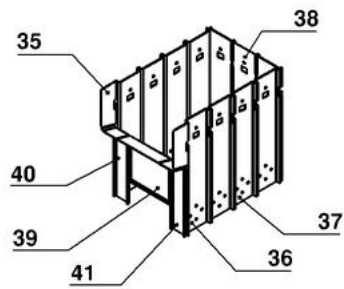

FOYER REFRACTAIRE / FEUERRAUM FORMSTEIN

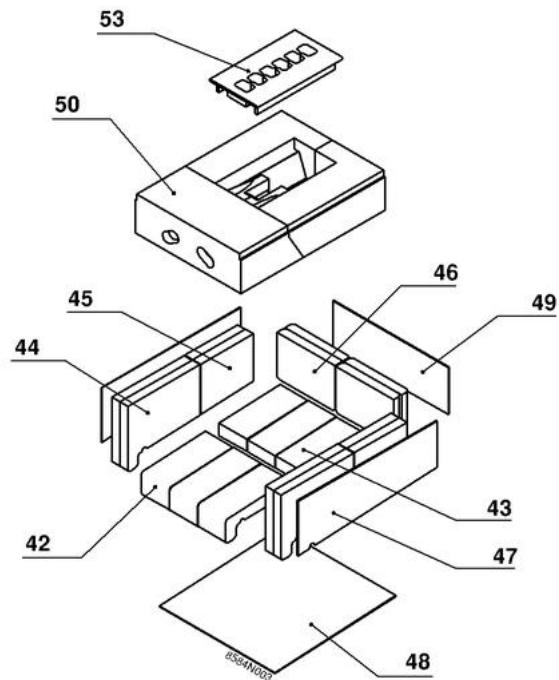

OUTILS / WERKZEUG

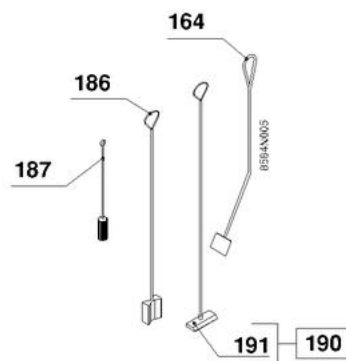







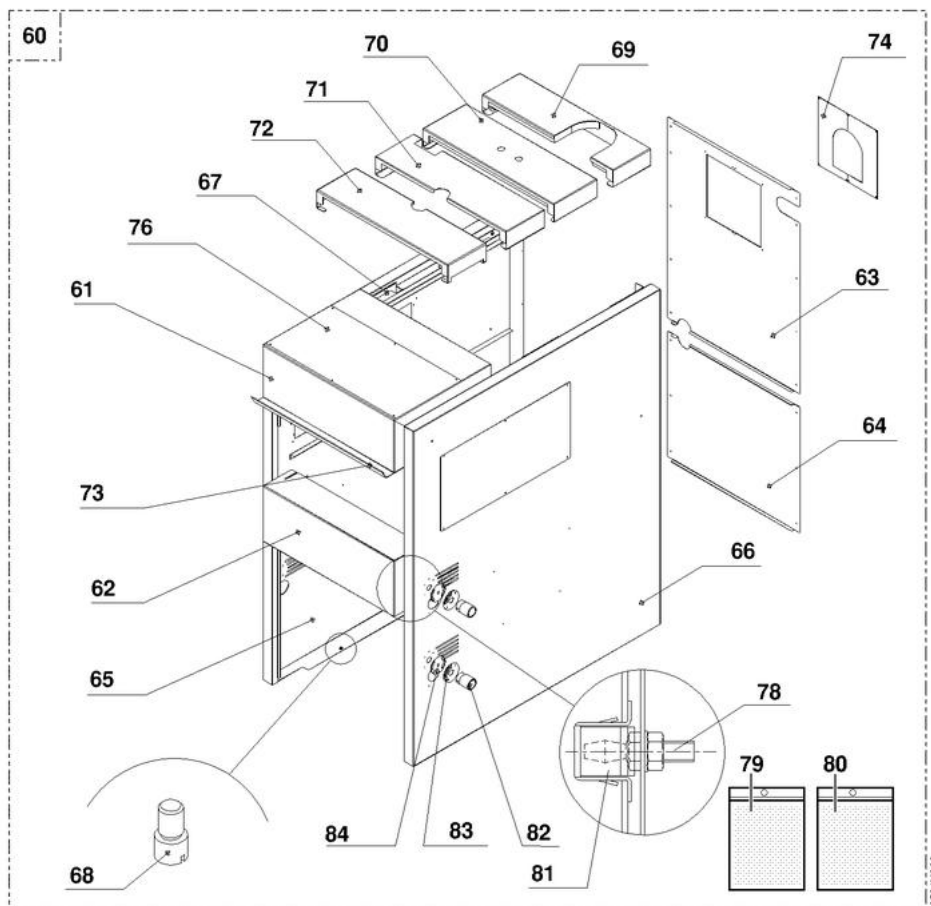









Réf.	Référenc	Description	Qté	Tarif	Substitut	Tarif Sub.	Remarques
	300000216	THERMOMETRE FUMEE	1	130,00 €			
35	97930716	PLAQUE FOYER COIN GAUCHE HK	1	96,10 €			⊘
35	97930718	PLAQUE FOYER COIN GAUCHE HK	1	123,00 €			
35	97930717	PLAQUE FOYER COIN GAUCHE HK	1	89,50 €			
36	97930719	PLAQUE FOYER COIN DROIT HK20	1	96,10 €			⊘
36	97930721	PLAQUE FOYER COIN DROIT HK45	1	111,00 €			⊘
36	97930720	PLAQUE FOYER COIN DROIT HK25	1	89,80 €			
37	97930764	PIECE DE FOY.LAT. HK20	1	51,10 €			
37	97930723	PLAQUE FOYER LATERALE HK25-3	1	56,50 €			
37	97930724	PLAQUE GOYER LATERALE HK45	1	71,00 €			
38	97930726	PLAQUE FOYER ARRIERE HK25-35	1	47,60 €			⊘
38	97930727	PLAQUE FOYER ARRIERE HK45	1	59,80 €			
39	97930729	PLAQUE FOYER AVANT HK25-35	1	53,00 €			
39	97930730	PLAQUE FOYER AVANT HK45	1	40,70 €			
40	97930732	PLAQUE FOYER AVANT GAUCHE F	1	38,60 €			⊘
40	97930733	PLAQUE FOYER AVANT GAUCHE F	1	40,50 €			
41	97930735	PLAQUE FOYER AVANT DROIT HK2	1	41,00 €			
41	97930736	PLAQUE FOYER AVANT DROIT HK2	1	48,20 €			
42	97930765	REFRACTAIRE AVANT BAS	1	51,00 €			
43	97930766	REFRACTAIRE ARRIERE BAS	1	43,10 €			
44	97930767	REFRACTAIRE AVANT LAT.	1	64,50 €			
45	97930768	REFRACTAIRE ARRIERE LAT.	1	47,30 €			⊘
46	97930769	REFRACTAIRE ARRIERE	1	43,10 €			⊘
47	97930770	JOINT LATERAL FOYER	1	23,10 €			⊘
48	97930771	JOINT INFERIEUR FOYER	1	30,00 €			
49	97930772	JOINT ARRIERE FOYER	1	14,70 €			⊘
50	97930773	REFRACTAIRE FOYER HK20-50	1	1167,00 €			⊘
53	97930774	GRILLE FOYER HK20-50 II	1	657,00 €			
164	97930739	CROCHET COURBE	1	Nous consulter ...			⊘
186	97930782	BROSSE 40X80X100/1100	1	39,10 €			
187	97930783	BROSSE D.40X100/500	1		97930782	39,10 €	
190	97930784	RACLETTTE H.55 L.140	1	78,70 €			
191	97930785	RACLETTTE COUDEE	1	62,10 €			

HK 2-
20-25-35-50

HABILLAGE / VERKLEIDUNG





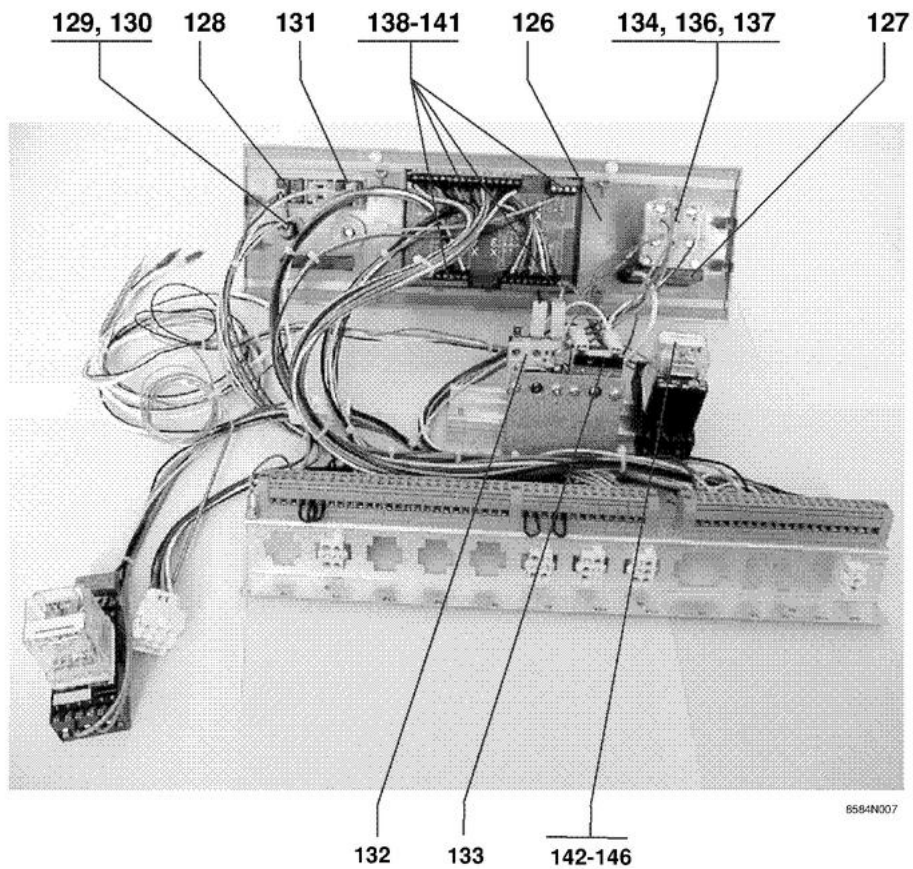

Réf.	Référenc	Description	Qté	Tarif	Substitut	Tarif Sub.	Remarques
60	85847017	HABILL.HK2 20a35KW MK17	1	Nous consulter ...			
60	85847018	HABILLAGE HK2 50KW MK18	1	Nous consulter ...			
61	97930893	PANNEAU AVANT SUPERIEUR	1	242,00 €			
62	97930895	PANN.AVANT CENT. HK 45-50	1	Nous consulter ...			
62	97930895	PANN.AVANT CENT. HK 45-50	1	Nous consulter ...			
62	97930894	PANN.AVANT CENT. HK 20-35	1	Nous consulter ...			
63	97930896	PANN.ARRIERE SUP.HK 20-35	1	107,00 €			
63	97930897	PANN.ARRIERE SUP.HK 45-50	1	Nous consulter ...			
64	97930898	PANN.ARRIERE INFERIEUR	1	54,40 €			
65	97930899	PANN.LAT.GAUCHE HK 20-35	1	Nous consulter ...			
65	97930900	PANN.LAT.GAUCHE HK 45-50	1	335,00 €			
66	97930901	PANN.LAT. DROIT HK 20-35	1	Nous consulter ...			
66	97930902	PANN.LAT. DROIT HK 45-50	1	344,00 €			
67	97930903	CHEMIN DE CABLE	1	Nous consulter ...			
68	97930904	VIS M5 X 5 VZ	1	5,20 €			
69	97930905	CHAPITEAU ARRIERE	1	Nous consulter ...			
70	97930906	CHAPITEAU TRAPPE RAMONAGE	1	Nous consulter ...			
71	97930907	CHAPITEAU CENTRAL 1	1	Nous consulter ...			
72	97930908	CHAPITEAU CENTRAL 2	1	84,70 €			
73	97930909	SPOILER	1	61,20 €			
74	97930910	CACHE TUBES ARRIERE	1	Nous consulter ...			
76	97930912	CACHE TABLEAU SUPERIEUR	1	Nous consulter ...			
78	97930914	VIS D.8 X 26 / M5	1	81,00 €			
79	97930640	SACHET ACCESSOIRE	1	Nous consulter ...			
80	97930639	SACHET VISSERIE HABILLAGE	1	Nous consulter ...			
81	97930915	GACHE	1	Nous consulter ...			
82	97930626	BOUTON DE REGLAGE	1	53,00 €			
83	97930627	PLAQUETTE	1	18,60 €			
84	97930916	ROSETTE AMENEE AIR	1	14,00 €			

**HK 2-
20-25-35-50**

TABLEAU DE COMMANDE M5.1 / M5.1-SCHALTFELD







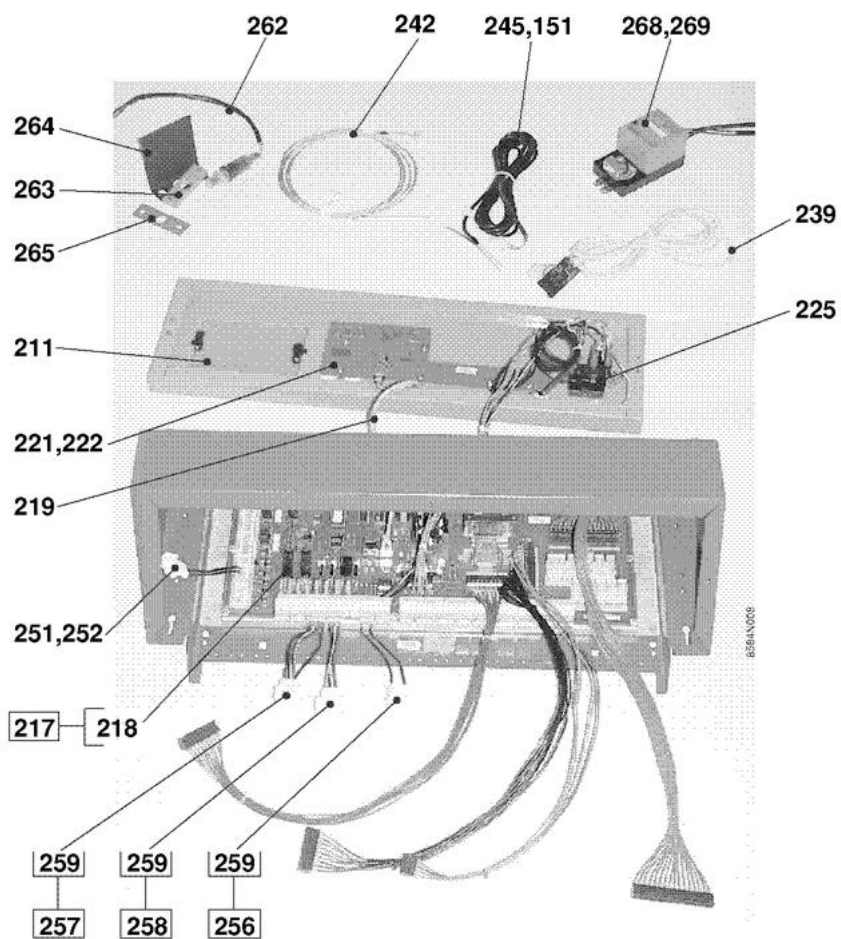

Réf.	Référenc	Description	Qté	Tarif	Substitut	Tarif Sub.	Remarques
	85847020	TABLEAU AV.REGUL.M5.1MK20	1	Nous consulter ...			
	95365489	SONDE KVT 40 LG.5M	1	35,10 €			
	97930881	SONDE KT10-40 / L.4000	1	55,80 €			
	97930885	SONDE RETOUR VF100N X10	1	95,90 €			
	97955402	SONDE EXTERIEURE AF200	1	34,40 €			
	95365491	SONDE KVT 40 LG.2M	1	25,70 €			
	97930787	CARCASSE TABLEAU	1	270,00 €			
	97930788	GACHE	1	1,90 €			
	97930789	PENE	1	1,90 €			
	97930790	CADRE TABLEAU	1	13,70 €			
	97938258	SONDE EXTERIEURE AF 100 N	1	61,60 €			
	97930791	CONNECTEUR	1	15,20 €			
	97930879	RESSORT MAINT. GAINÉ THER	1	4,70 €			
	97930883	COUVERCLE REGULATION TOP.	1	7,65 €			
	97930891	INTERRUPTEUR	1	62,90 €			
	97930892	INTERRUPTEUR DOUBLE	1	24,60 €			
	97938248	SONDE VF 100 N E	1	60,60 €			
126	97930792	FACADE TABLEAU	1	33,60 €			
127	97930793	THERMOMETRE	1	63,60 €			
128	97930794	INTERRUPTEUR MARCHE/ARRET	1	8,20 €			
129	97938186	PORTE FUSIBLE	1	Nous consulter ...			
130	97938187	FUSIBLE 6.3A 5X20 250V	1	2,05 €			
131	97930797	VOYANT VERT	1	14,70 €			
132	97930431	THERMOSTAT DE REGLAGE	1	99,50 €			
133	97930798	THERMOSTAT FUMEE 200°C	1	49,70 €			
134	97930799	THERMOSTAT DOUBLE	1	133,00 €			
136	97930796	BOUTON REGLAGE	1	10,60 €			
137	97930870	ARRET RESSORT	1	1,85 €			
138	97938176	CONNECTEUR X3 - 9 PTS - 1 A 9	1		97953402	12,40 €	
139	97938177	CONNECTEUR X4 - 9 PTS - 10 A 18	1		97953403	12,10 €	
139	97938178	CONNECTEUR X2 - 4 PTS - 22 A 19	1		97953401	7,20 €	
141	97938179	CONNECTEUR X1 - 16 PTS - 38 A 2	1		97953400	18,90 €	
142	97930875	SOCLE RELAIS	1	23,10 €			
143	97930430	RELAIS	1	Nous consulter ...			
144	97930876	RELAIS TEMPORISE	1	209,00 €			
145	97930877	SET RELAIS TEMPORISE+SOCL	1	255,00 €			
146	97930878	RESISTANCE 0.1µF/470 OHM	1	10,80 €			
200	88017023	REGULATION SV-MATIC 23B AD20E	1	1007,00 €			
200	88017024	REG ECS SV MAT.233B AD206	1	1458,00 €			

**HK 2-
20-25-35-50**

TABLEAU DE COMMANDE M5.4 / M5.4-SCHALTFELD



Réf.	Référenc	Description	Qté	Tarif	Substitut	Tarif Sub.	Remarques
	300000361	CONNECTEUR 2 POLES	1	6,25 €			
	300000362	CONNECTEUR 3 POLES	1	9,10 €			
	300000363	CONNECTEUR 4 POLES	1	11,60 €			
	95365489	SONDE KVT 40 LG.5M	1	35,10 €			
	97938258	SONDE EXTERIEURE AF 100 N	1	61,60 €			
	95365491	SONDE KVT 40 LG.2M	1	25,70 €			
	97930884	THERMOSTAT CONTACT 0-60°	1	234,00 €			
	97955402	SONDE EXTERIEURE AF200	1	34,40 €			
	300000326	CARCASSE TABLEAU	1	Nous consulter ...			
	300000328	COUVERCLE TABLEAU M5.4	1	64,30 €			
	300000364	CONNECTEUR 5 POLES	1	14,40 €			
	300000366	CONNECTEUR 6 POLES	1	16,60 €			
	97930789	PENE	1	1,90 €			
	97930879	RESSORT MAINT. GAINÉ THER	1	4,70 €			
	97938248	SONDE VF 100 N E	1	60,60 €			
151	97930881	SONDE KT10-40 / L.4000	1	55,80 €			
211	97938169	CONNECTEUR	1	Nous consulter ...			
217	300000329	CARTE UC M5.4	1	2601,00 €			
218	300000330	EPROM CARTE UC M5.4	1	60,40 €			
219	300000333	CABLE LIAISON CARTES UC-AFFIC	1	57,30 €			
221	300000334	CARTE AFFICHAGE M5.4	1	409,00 €			
222	300000367	CLAVIER ELASTOMERE HK2	1	1,00 €			
225	300000335	THERMOSTAT SECURITE 100-130°	1	Nous consulter ...			
239	300000341	CABLE D'ADAPTATION VENTILATEI	1	94,20 €			
242	300000342	SONDE FUMEE	1	222,00 €			
245	300000343	SONDE CHAUDIERE KT10/25/6	1	52,20 €			
251	300000344	CONNECTEUR SONDE	1	86,50 €			
252	300000345	CONNECTEUR 3PLTS AMP. FEM	1	1,50 €			
256	300000346	CONNECTEUR CONTACTEUR POR	1	86,50 €			
257	300000349	CONNECTEUR VANNE 3 VOIES	1	86,50 €			
258	300000350	CONNECTEUR POMPE AUX.	1	1,00 €			
259	300000351	CONNECTEUR 6PLOTS	1	1,00 €			
262	300000353	SONDE LAMBDA M5.4	1	Nous consulter ...			
263	300000354	BRIDE SONDE	1	177,00 €			
264	300000355	TOLE DE PROTECTION SONDE	1	19,60 €			
265	300000356	JOINT SONDE	1	2,10 €			
268	300000358	MOTEUR CLAPET AIR BELIMO LM2	1	774,00 €			
269	300000360	MOTEUR CLAPET AIR BELIMO LM2	1	774,00 €			

**HK 2-
20-25-35-50**

TABLEAU DE COMMANDE M5.4 (suite) / M5.4-SCHALTFELD (Fortsetzung)

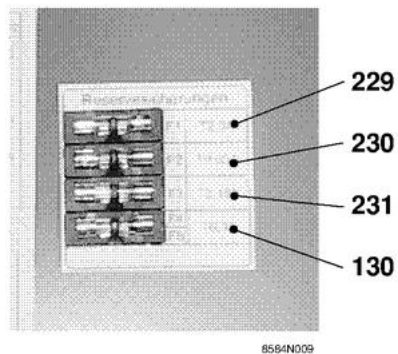
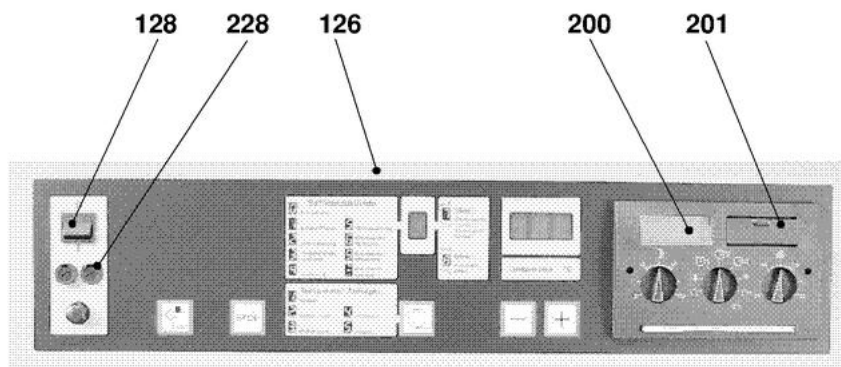

Réf.	Référenc	Description	Qté	Tarif	Substitut	Tarif Sub.	Remarques
122	97930788	GACHE	1	1,90 €			
126	300000327	FACADE TABLEAU M5.4	1	Nous consulter ...			
128	97930794	INTERRUPTEUR MARCHE/ARRET	1	8,20 €			
130	97938187	FUSIBLE 6.3A 5X20 250V	1	2,05 €			
200	88017023	REGULATION SV-MATIC 23B AD20€	1	1007,00 €			
200	88017024	REG ECS SV MAT.233B AD206	1	1458,00 €			
201	97930883	COUVERCLE REGULATION TOP.	1	7,65 €			
228	300000337	PORTE-FUSIBLE	1	24,70 €			
229	300000338	FUSIBLE 2A 5X20 250V	1	2,20 €			
230	300000340	FUSIBLE 0.5A 5X20 250V	1	9,80 €			
231	97938165	FUSIBLE 3.15A 5X20 250V	1	3,50 €			

**HK 2-
20-25-35-50**

KITS HYDRAULIQUES / ROHRVERBINDUNGSSÄTZE

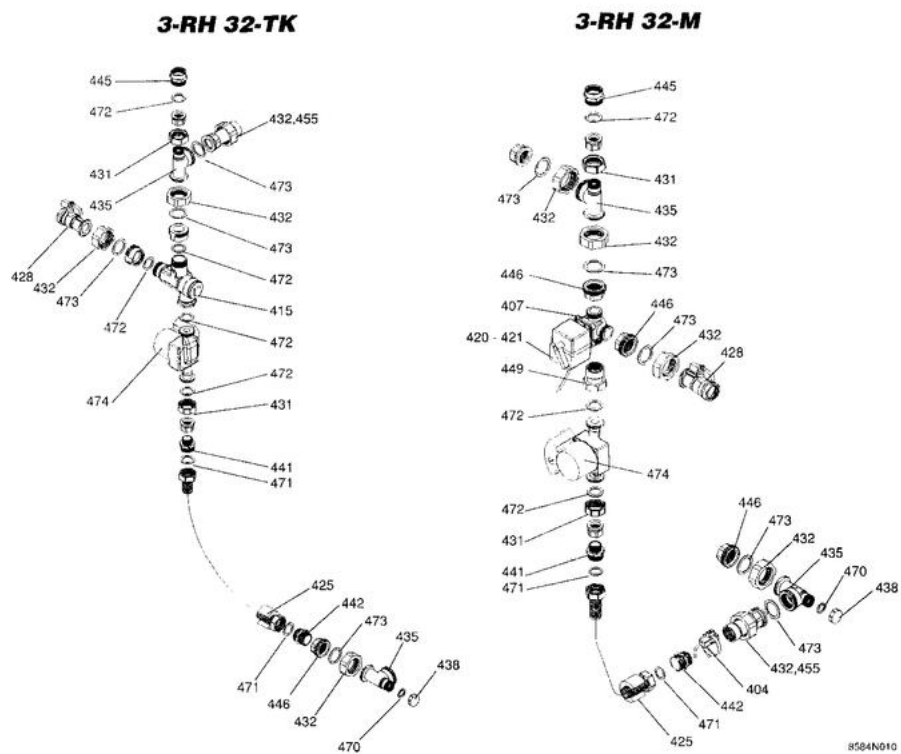

Réf.	Référenc	Description	Qté	Tarif	Substitut	Tarif Sub.	Remarques
	300000753	CABLE CIRCULATEUR	1	Nous consulter ...			⊘
404	97930885	SONDE RETOUR VF100N X10	1	95,90 €			
407	300000754	VANNE 3 VOIES 1-1/4"	1	440,00 €			
415	300000755	VANNE THERMOSTATIQUE	1	1126,00 €			
420	300000756	MOTEUR VANNE 3-VOIES NR 230-0	1	416,00 €			
421	300000757	ACCOUPLLEMENT MOTEUR V3V	1	53,70 €			
425	300000768	FLEXIBLE ISOLEE 1-1/4" LG.650MM	1	349,00 €			⊘
428	300000759	ROBINET 1/4 TOUR 1-1/4"	1	126,00 €			
431	300000784	ECROU 1-1/2"	1	8,25 €			
432	300000783	ECROU 2"	1	20,80 €			
435	300000770	RACCORD TE DN 32-2"	1	89,00 €			⊘
438	300000785	BOUCHON 1" + JOINT	1	13,10 €			
441	300000771	MAMELON DOUBLE 1" X 1-1/4"	1	28,50 €			
442	300000781	MAMELON DOUBLE 1-1/4"	1	57,70 €			
445	300000773	RACCORD 1-1/4" / 1-1/2"	1	47,80 €			
446	300000782	RACCORD M/F 2" X 1-1/4"	1	39,20 €			
449	300000769	RACCORD 1-1/4" / 1"	1	Nous consulter ...			⊘
455	300000767	TUBE DE RACCORDEMENT 1-1/4" >	1	73,30 €			
470	95013062	JOINT VERT 30X21X2	1	1,00 €			
471	95013063	JOINT FIBRE D.38 X 27 X 2	1	1,65 €			
472	95013064	JOINT VERT 44X32X2	1	1,25 €			
473	95013065	JOINT FIBRE D.56 X 42 X 2	1	3,05 €			
474	95132255	CIRCULATEUR RS 25/65R 180 - 12F	1		7643736	176,00 €	

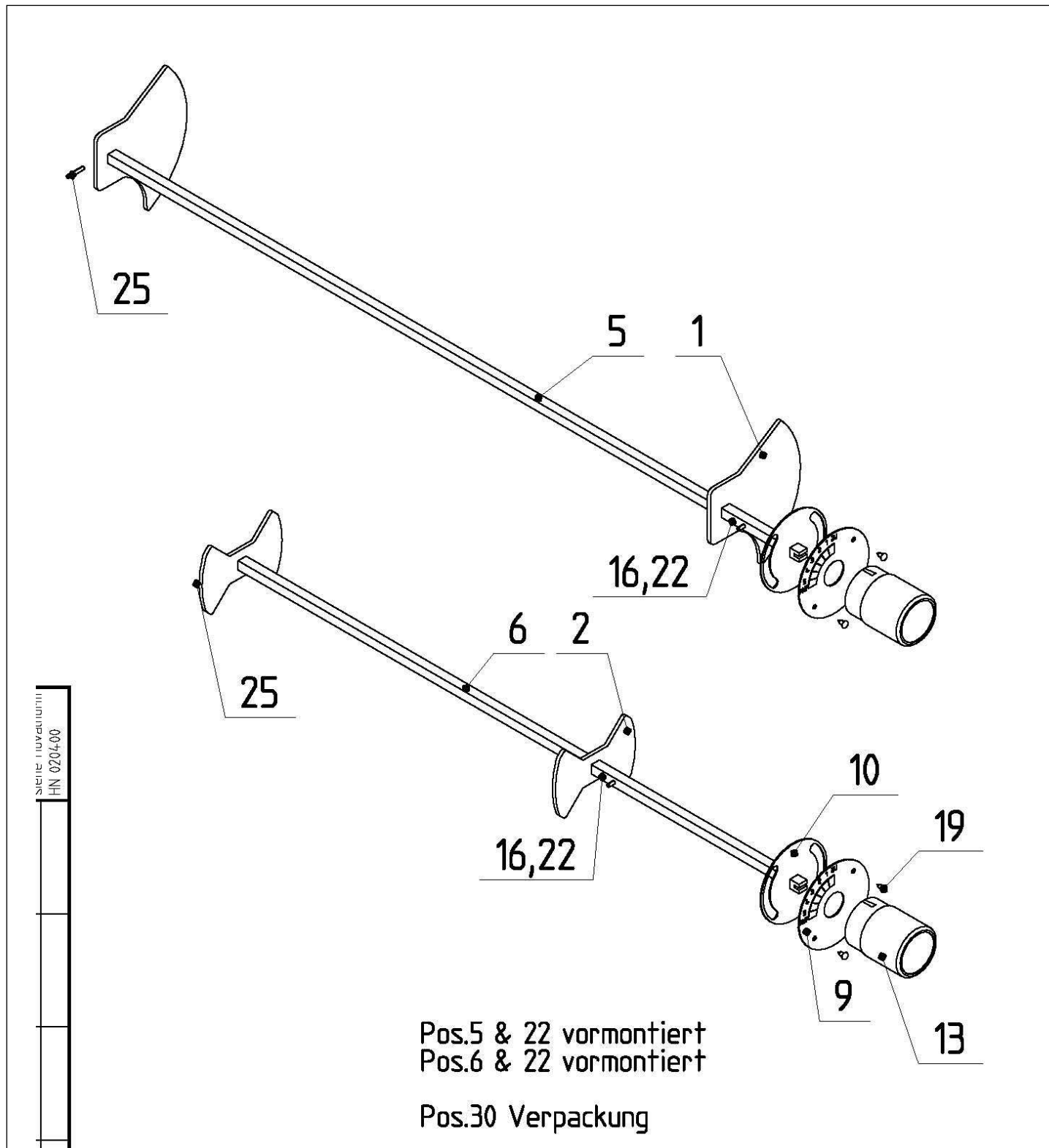

Réf.	Référenc	Description	Qté	Tarif	Substitut	Tarif Sub.	Remarques
1	300003851	CLAPET AIR PRIMAIRE	1	8,90 €			
2	300003852	CLAPET AIR SECONDAIRE	1	8,10 €			
5	300003853	AXE CARRE PRIMAIRE	1	34,60 €			
6	300003854	AXE CARRE PRIMAIRE	1	31,70 €			
9	97930627	PLAQUETTE	1	18,60 €			
10	97930916	ROSETTE AMENEE AIR	1	14,00 €			
13	97930626	BOUTON DE REGLAGE	1	53,00 €			
16	300003858	RESSORT	1	9,55 €			
22	300003859	GOUPILLE D3X16	1	1,00 €			
25	300003870	GOUPILLE 3.2X25	1	1,00 €			