

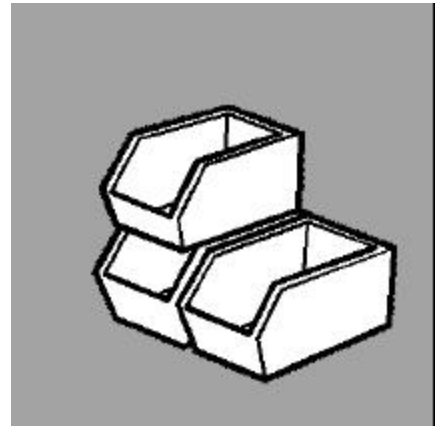





















Ersatzteilliste Öl-Gebläsebrenner
Spare part list Oil burner
Vue éclatée Brûleur à fioul domestique
C.300 H901



	Pos. Pos. Pos.	Bezeichnung Description Description		Artikel-Nr. Article-No. Nr. articles
Baugruppe: Ass.group: Ensemble:	1	Grundausstattung Basis equipment Equipement de base		
	1.2	Schauglas Sight glass Regard	55x21	
	1.3	Schauglasdeckel Sight glass cover Couvercle pour regard	D55	
	1.4	Dichtung (Schwenkflansch) Swivel flange Joint	D 320x320x8 BO 230	
Baugruppe: Ass.group: Ensemble:	2.20	Zündtrafo BG m. Zündkabel Ignition transformer Transformateur d'allumage	ZM 20/14	
	2.20.1	Zündtrafo Ignition transformer Transformateur d'allumage	ZM20/14	13019271
	2.20.2	Zündkabel, spezial Ignition lead Câble d'allumage	1500 mm	13019255
Baugruppe: Ass.group: Ensemble:	4	Motor BG Motor Moteur	400/690V	
	4.1	Motor Motor Moteur	4,0kW 400/690V 50Hz	13019335 
Baugruppe: Ass.group: Ensemble:	5	Ventilatorrad BG Air fan ass. Turbine	450/224x86	
	5.1	Ventilatorrad Air fan Turbine	450/224x86 D 24	13019250
Baugruppe: Ass.group: Ensemble:	6	Luftansaugkasten kpl. Air intake housing cpl. Boîte à air cpl.		

	Pos. Pos. Pos.	Bezeichnung Description Description		Artikel-Nr. Article-No. Nr. articles
Baugruppe: Ass.group: Ensemble:	10	Pumpenaggregat Pump ass. Groupe pompe	SMG 16026-D-20-SO 735l/h 30bar EL	
	10.1	Motor Motor Moteur	1,1 kW 230/400V 50Hz 2800/min	13019336 
	10.2	Pumpe Pump Pompe	VBGR MZ-D-4-20-SO 735l/h	13019337 
	10.3	Dichtungssatz Gasket for pump Ensemble de joints pour la pompe	D12	13019338 
	10.4	Kupplung kpl. Coupling Accouplement		13019339
	10.4.1	- Elastischer Zahnkranz f. Kupplung Elastic gear rim for coupling Accouplement élastique		13019340
Baugruppe: Ass.group: Ensemble:	11	Druckwächter BG Pressure switch Pressostat différentiel	DL 50 A	
	11.1	Luftdruckwächter Air pressure switch Pressostat air	DL 50A 2,5-50 mbar	13019251
Baugruppe: Ass.group: Ensemble:	12	Ölschlauch BG Oil hose Flexible fuel	DN20x1500 M30x1,5	13019341
	12.1	Ölschlauch Oilhose Flexible fuel	M 30x1,5 DN20 L=1500 mm	13019342 
Baugruppe: Ass.group: Ensemble:	12.10	Anschluss BG RDN-Stange DN8 Connection Connexion		
	12.10.1	Einschraubverschraubung, gerade Screwed connection Raccord fileté		
	12.10.2	Ölschlauch Oilhose Flexible fuel	DN 8 L=700	13019343 
	12.10.3	Einschraubstutzen, gerade Screw in end Raccord tubulure		
	12.10.4	Überwurfmutter Union nut Écrou de raccord	M10L	
	12.10.5	Profiling Profile ring Rondelle profile	P -R 10L/S DIN267	

	Pos. Pos. Pos.	Bezeichnung Description Description		Artikel-Nr. Article-No. Nr. articles
Baugruppe:	14	Lanzengaskopf Grundl.		
Ass.group:		Lanee gas head basis ext.		
Ensemble:		Tête gaz multijet		
	14.10	Flammenrohr Grundl. Flame tube Gueulard	D235/263x276	13019344 
	14.20	Stauscheibe Brake plate Accrocheur	D190/54 Tk 110	13019361 
	14.70	Düsengestänge Nozzle rod Ligne fuel	RDN L=202	
	14.80	DG- Zentrierung BG Nozzle rod centering Linge fuel centrage		
	14.80.1	- Zündelektrode Ignition electrode Électrode d'allumage	D11x100+85mm	13019346 
Baugruppe:	14	Lanzengaskopf 100 Verl.		
Ass.group:		Lanee gas head		
Ensemble:		Tête gaz multijet		
	14.10	Flammenrohr 100 Verl. Flame tube Gueulard	D235/263x376	13019347 
	14.70	Düsengestänge Nozzle rod Ligne fuel	RDN L=286	
Baugruppe:	14	Lanzengaskopf 200 Verl.		
Ass.group:		Lanee gas head		
Ensemble:		Tête gaz multijet		
	14.10	Flammenrohr 100 Verl. Flame tube Gueulard	D235/263x476	13019348 
	14.70	Düsengestänge Nozzle rod Ligne fuel	RDN L=370	
Baugruppe:	20	Beipack	EK 6	
Ass.group:		Accessory		
Ensemble:		Accessoires		
	20.1	Dichtung (Kesselseitig) Swivel flange Joint	D 320x320x3	13019349 

	Pos.	Bezeichnung		Artikel-Nr.
	Pos.	Description		Article-No.
	Pos.	Description		Nr. articles
Baugruppe:	21	Überwachungsbaugruppe		
Ass.group:		Flame monitor system		
Ensemble:		Le contrôle de flamme		
	21.1 A	Flammenfühler Flame sensor Sonde de flamme	QRB 3	13019350 
	21.1 B	Flammenfühler Flame sensor Sonde de flamme	RAR 7	13019351 
	21.1 C	Flammenfühler Flame sensor Sonde de flamme	FFS 06	13019352 
Baugruppe:	22	Elektroausstattung		
Ass.group:		Electric equipment		
Ensemble:		Electric montage en saillie		
	22.1 A	Elektro BG Electric ass. Electric ass.	BCS-300	
	22.1.1	- Stellantrieb Actuator Servo-moteur	SAD 15.0	13019296
	22.1.2	- Flammenwächter Flame detector Le détecteur de flamme	BCS-FLW 05	13019297
	22.1.3	- BCS-Grundmodul BCS-basic module BCS-module base	BCS 300	13019298
	22.1.5	- Motorschutzrelais Relay Relais	f. 4kW (Brennermotor)	
	22.1.6	- Motorschutzrelais Relay Relais	f. 1,5kW (Pumpe)	
	22.1.7	- Leistungsschütz Relay Relais	5,5kW B7-30-01 220-240V 40-450HZ	
	22.1 B	Elektro BG Electric ass. Electric ass.	Lamtec EVR	
	22.1.1	- Stellantrieb Actuator Servo-moteur	STM 30/40 Q15	13019360

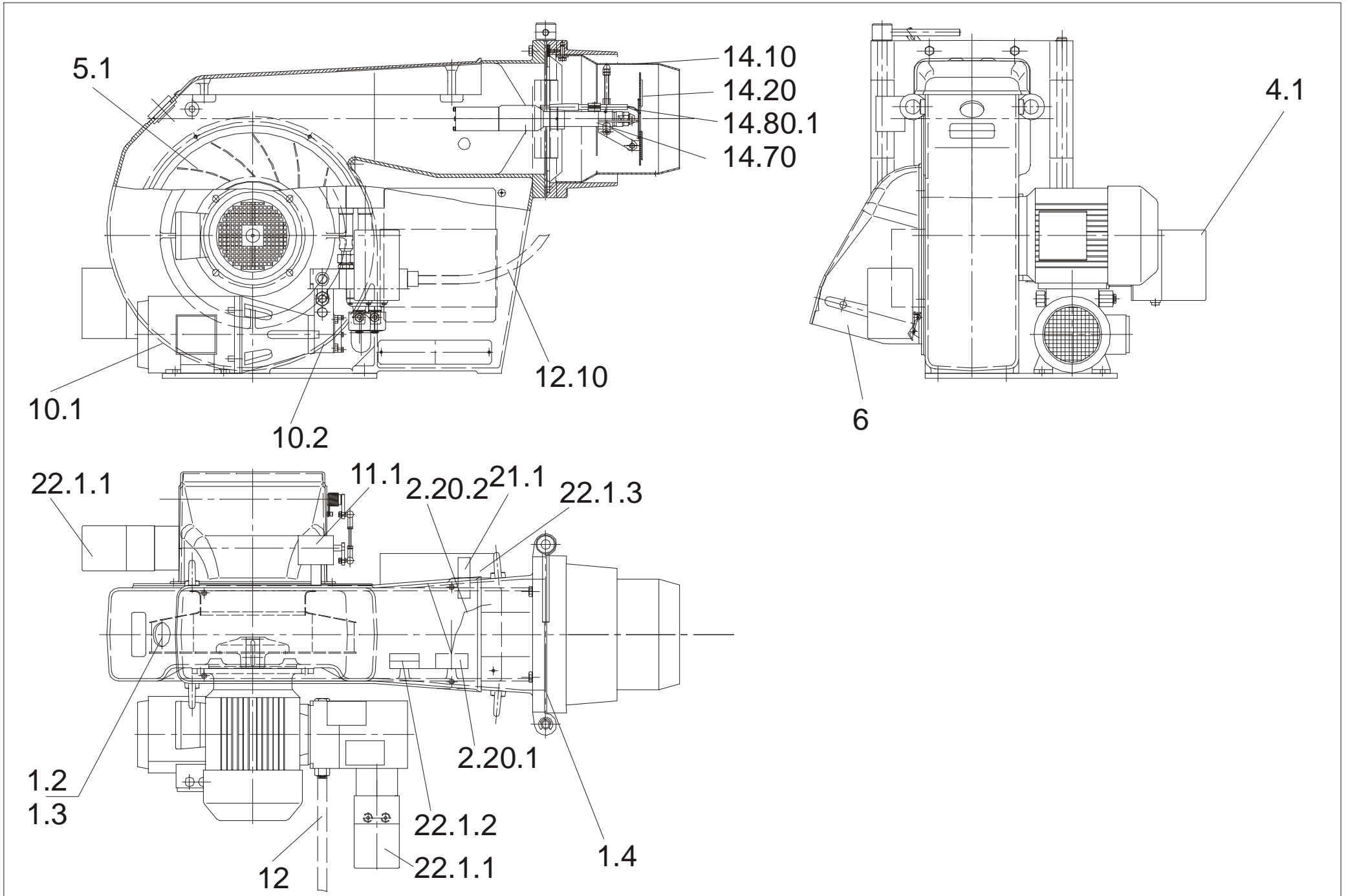

Ausstattung: Ölhydraulik, Ölregelwelle und Öldüse sind kommissionsbezogen zu bestellen.

Equipment: Oil hydraulic, oil control shaft and oil nozzle as ordered for commission specification.

Accessoires: L'hydraulique fuel, l'arbre de réglage et le gicleur doivent être commandés en fonction de l'installation.

Weitere Teile auf Anfrage.

Further spare part on request.

Autres pièces détachées sur demande.

Revision

Nr.:	Ausg.:	gilt für Brenner ab:	Änderung:
1	11/00	09/00	Neu
2	12/01	12/01	ÄM15070 Elektro-BG

Änderungen im Sinne der technischen Weiterentwicklung vorbehalten.

Modifications to incorporate latest technical developments are reserved.

Sous réserve de modifications résultant du perfectionnement technique.

Kundendienst:
Service:
Votre service après-vente:

CUENOD
18, rue des Buchillons
F - 74100 ANNEMASSE Cedex