

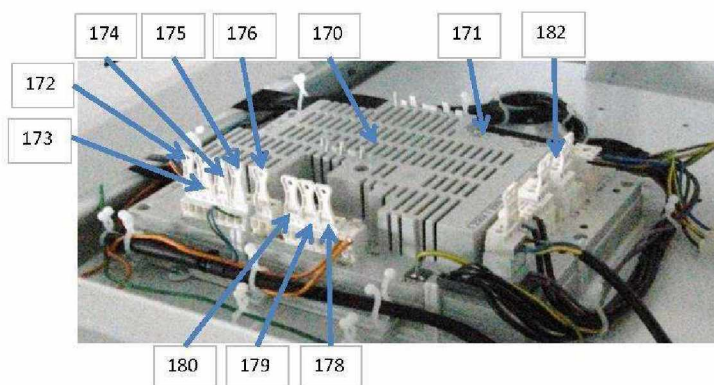

SGB 400-470-540-610 E

	ACCESSOIRES	
--	-------------	--

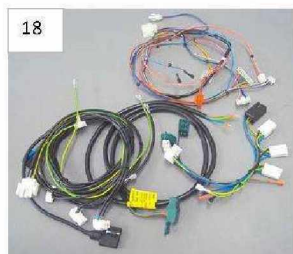
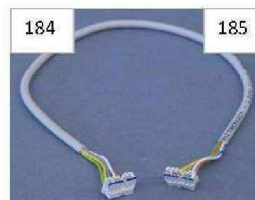
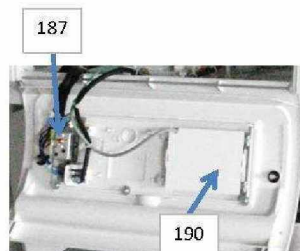
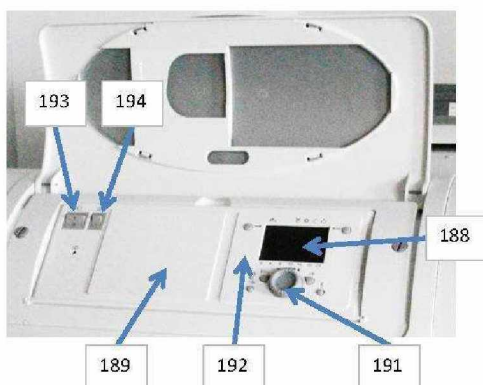

Réf.	Référenc	Description	Qté	Tarif	Substitut	Tarif Sub.	Remarques
18	7714237	CABLAGE SGB 400-610 i	1	137,00 €			
0	7307381	FILTRE A AIR MOOREA 400-610	1	641,00 €			
170	SRN68148	CARTER PLATINE	1	17,00 €			
171	SRN63593	FUSIBLE AVEC SUPPORT	1	5,50 €			
172	SRN68150	CONNECTEUR H5	1	5,00 €			
173	SRN68151	CONNECTEUR H4	1	5,00 €			
174	SRN68152	CONNECTEUR UH	1	5,00 €			
175	SRN68153	CONNECTEUR H1	1	5,00 €			
176	SRN62749	CONNECTEUR POUR SONDE EXTE	1	8,10 €			
178	SRN67137	DOUILLE RAST5 02K09 BX3	1	4,10 €			
179	SRN67138	DOUILLE RAST5 02K09 BX2	1	4,10 €			
180	SRN67139	DOUILLE RAST5 02K09 BX1	1	4,10 €			
182	SRN64137	FICHE CONNECTION P/REGUL.LML	1	16,40 €			
183	SRN73073	CABLAGE CHAUDIERE SGB400/610	1	245,00 €			[To Translat =]
184	SRN65662	CABLE BUS UNITE DE CDE LG430M	1	10,20 €			
185	SRN69588	CABLE BUS UNITE DE CDE LG570M	1	12,10 €			
187	SRN73073	THERMOSTAT DE SECURITE STB 1	1				
188	SRN81154	DISPLAY/AFFICHEUR UNIVERSEL	1	166,00 €			
189	SRN73073	SUPPORT UNITE DE COMMANDE S	1	31,20 €			
190	SRN68138	CARENAGE UNITE DE COMMANDE	1	10,90 €			
191	SRN62743	BOUTON ROTATIF UNITE CDE ISR	1	5,40 €			
192	SRN68823	BOUCHON CAOUTCHOUC CONNEC	1	3,20 €			
193	SRN62740	COMMUTATEUR	1	6,60 €			
194	SRN62745	BOUTON POUSSOIR	1	8,10 €			
195	SRN73073	KIT D'ENTRETIEN SGB 400 E	1				[To Translat =]
195	7307345	KIT D ENTRETIEN / SGB 470E	0				
195	7307346	KIT ENTRETIEN SGB 540 E	0	291,00 €			
195	7307347	SET ENTRETIEN SGB 610 E	0				
196	SRN73073	KIT JOINT D'ENTRETIEN SGB E 400	1	214,00 €			[To Translat =]



SGB 470 H.T.E

	BRULEUR	
--	----------------	--

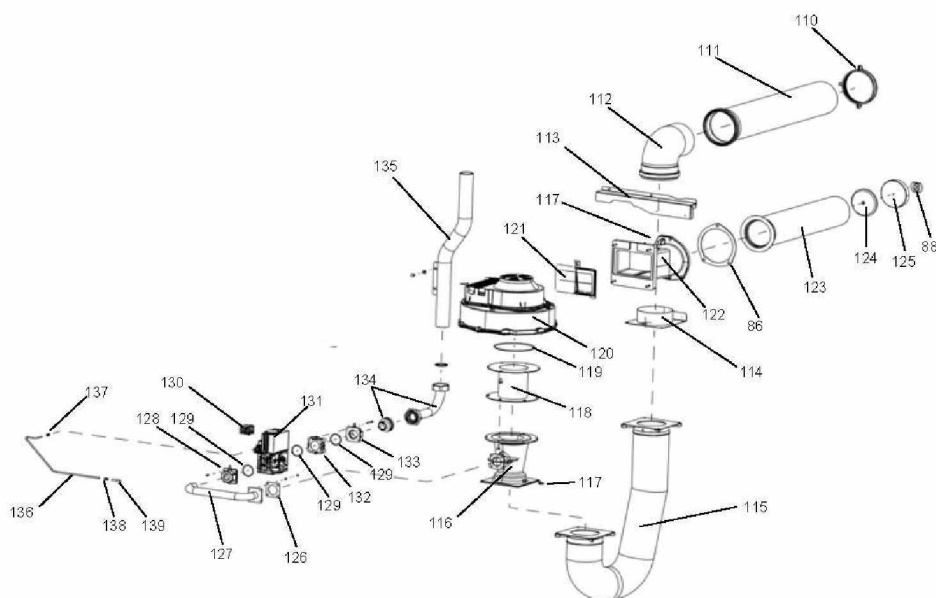

Réf.	Référenc	Description	Qté	Tarif	Substitut	Tarif Sub.	Remarques
86	SRN73072	JOINT OBTURATEUR PASSAGE BR	1	32,40 €			
88	SRN73072	CLIP DE MAINTIEN ISOLANT OBTU	1	18,60 €			
110	SRN69539	FIXATION TUYAUTERIE D'AIR DN16	1	14,00 €			
111	SRN73072	TUYAUTERIE D'AIR 1222MM DN160	1	138,00 €			
112	SRN73072	COUDE 90° AIR DN 160	1	47,70 €			
113	SRN73072	SUPPORT TUYAUTERIE D'AIR 894M	1	29,10 €			
114	SRN73072	DIAPHRAGME D'AIR MOOREA 400/6	1	125,00 €			
115	SRN73072	TUYAUTERIE FLEXIBLE D'AIR DN16	1	279,00 €			
116	SRN73072	VENTURI TYPE VMU500 MOOREA 4	1	624,00 €			
117	SRN73072	PRISE DE PRESSION R1/8"	1	12,60 €			
117	SRN73072	PRISE DE PRESSION R1/8"	1	12,60 €			
118	SRN73072	MANCHETTE VENTURI-VENTILATE	1	140,00 €			
119	SRN73072	JOINT TORIQUE 180X3,5	1	13,10 €			
120	SRN73072	VENTILATEUR TYPE G3G250GN442	1	2165,00 €			
121	SRN73072	CLAPET D'AIR SGB 400-610 E	1	97,00 €			
122	SRN73072	MELANGEUR D'AIR MOOREA 400/6	1	301,00 €			
123	SRN73072	TUBE BRULEUR SGB 470 E	1	2600,00 €			
124	SRN73072	PLAQUE ISOLANTE TUBE BRULEUR	1	33,40 €			
125	SRN73072	CAPUCHON TUBE BRULEUR SGB 4	1	56,50 €			
126	SRN73072	JOINT-VENTURI TUBE GAZ SGB 40	1	19,80 €			
127	SRN73072	TUBE GAZ MOOREA 400/610E	1	231,00 €			
128	SRN82306	BRIDE SORTIE VANNE GAZ SGB 40	1	37,60 €			
129	SRN73072	JOINT TORIQUE 52x3,5	1	10,20 €			
129	SRN73072	JOINT TORIQUE 52x3,5	1	10,20 €			
129	SRN73072	JOINT TORIQUE 52x3,5	1	10,20 €			
130	SRN73072	PRESSOSTAT GAZ SGB 400-540 E	1	92,40 €			
131	SRN73072	VANNE GAZ TYPE VR434VE5021 S	1	1505,00 €			
132	SRN73072	FILTRE GAZ SGB 400-540 E	1	63,20 €			
133	SRN82311	BRIDE ENTREE VANNE GAZ SGB 40	1	51,30 €			
134	SRN73072	FLEXIBLE GAZ SGB 400-540 E	1	415,00 €			
135	SRN73072	TUBE GAZ MOOREA 400/610E	1	250,00 €			
136	SRN73072	TUBE RILSAN 6x1 MM	1	16,50 €			
137	SRN73072	RACCORD TUBE RILSAN-VANNE G	1	21,10 €			
138	SRN73072	RACCORD TUBE RILSAN-VANNE G	1	21,10 €			
139	SRN73072	ADAPTATEUR 1/8"-M5 SGB 400-540	1	72,10 €			



SGB 470 E

nov-12

CORPS DE CHAUFFE

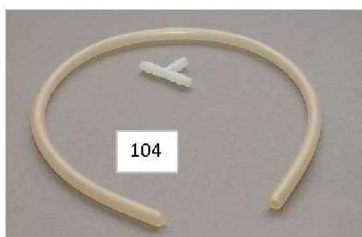
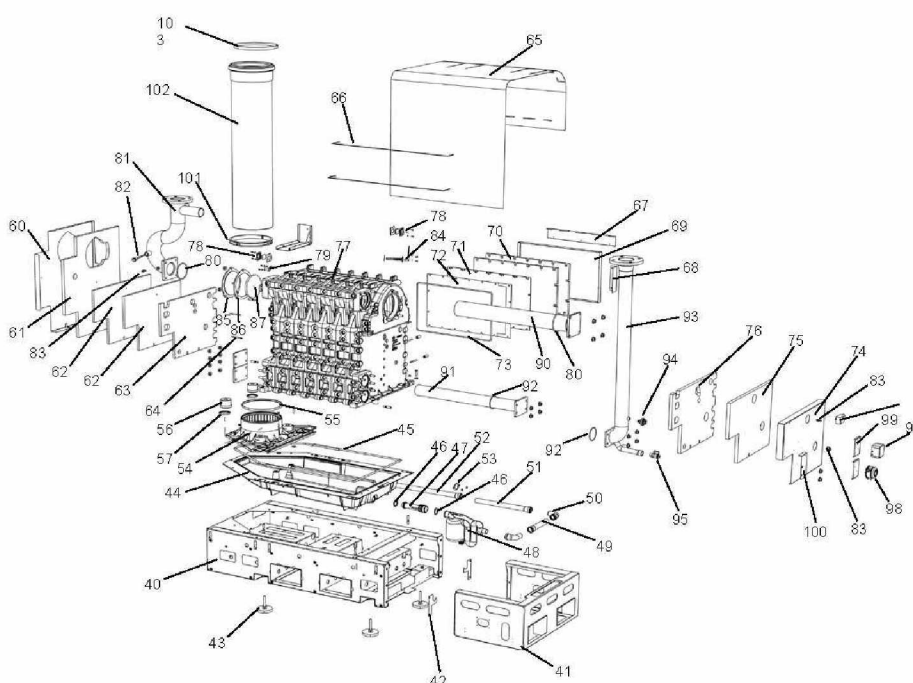

1

SGB 470 E - CORPS DE CHAUFFE_Vue

Réf.	Référenc	Description	Qté	Tarif	Substitut	Tarif Sub.	Remarques
40	SRN73071	SOCLE CHAUDIERE ARRIERE MOC	1	1653,00 €			
41	SRN73071	SOCLE ARRIERE MOOREA 400-610	1	516,00 €			
42	SRN73071	SUPPORT TUYAUTERIE CONDENS	1	18,70 €			
43	SRN73071	PIED REGLAGE M12X80 D100	1	49,80 €			
44	SRN73071	BAC A CONDENSATS MOOREA 470	1	504,00 €			
45	SRN73071	JOINT BAC A CONDENSATS MOOR	1	85,70 €			
46	SRN73071	JOINT 45X34X3, EPDM	1	17,90 €			
46	SRN73071	JOINT 45X34X3, EPDM	1	17,90 €			
47	SRN73071	TUBE BAC CONDENSEUR-SIPHON	1	29,30 €			
48	SRN73071	SIPHON MOOREA 400-600E	1	79,20 €			
49	SRN73071	TUBULURE CONDENSATS 218MM I	1	28,10 €			
50	SRN73071	COUDE 90°CONDENSATS MOORE	1	21,50 €			
51	SRN73071	TUBULURE CONDENSATS 400MM I	1	41,60 €			
52	SRN73071	TUBULURE CONDENSATS 1500MM	1	23,60 €			
53	SRN73071	BAGUE DE FIXATION TUBULURE C	1	13,20 €			
54	SRN73071	ADAPTATEUR SORTIE FUMEEES MC	1	134,00 €			
55	SRN73071	JOINT ADAPTATEUR SORTIE FUME	1	10,60 €			
56	SRN73071	BOUCHON DE REMPLISSAGE BAC	1	20,00 €			
57	SRN73071	JOINT BOUCHON DE REMPLISSAG	1	70,60 €			
60	SRN73071	TOLE PROTECTION ISOLANT ARRII	1	82,90 €			
61	SRN73071	ISOLANT ARRIERE EXTERIEUR MC	1	23,50 €			
62	SRN73071	ISOLANT ARRIERE MILIEU MOORE	1	30,30 €			
63	SRN73071	ISOLANT ARRIERE INTERIEUR MO	1	29,60 €			
64	SRN73071	GOUJON M6X70	1	13,10 €			
65	SRN73071	ISOLANT CORPS DE CHAUFFE MO	1	96,20 €			
66	SRN73071	EPINGLE 853MM MOOREA 470E	1	23,50 €			
67	SRN73071	SUPPORT ISOLANT CORPS DE CH	1	26,80 €			
68	SRN73071	PLAQUE DE FIXATION ISOLANT AV	1	33,20 €			
69	SRN73072	TOLE PROTECTION ISOLANT TRAF	1	54,50 €			
70	SRN73072	ISOLANT TRAPPE DE VISITE MOOF	1	23,80 €			
71	SRN73072	TRAPPE DE VISITE MOOREA 470E	1	146,00 €			
72	SRN73072	JOINT TRAPPE DE VISITE MOOREA	1	165,00 €			
73	SRN73072	JOINT CORPS DE CHAUFFE TRAPF	1	26,60 €			
74	SRN73072	TOLE PROTECTION ISOLANT AVAN	1	53,10 €			
75	SRN73072	ISOLANT AVANT EXTERIEUR MOOI	1	22,30 €			
76	SRN73072	ISOLANT AVANT INTERIEUR MOOF	1	24,00 €			
77	SRN73072	CORPS DE CHAUFFE MOOREA 470	1	12000,00 €			
78	SRN73072	ENSEMBLE VISEUR DE FLAMME SC	1	17,30 €			
79	SRN73072	TOLE ET JOINT DE FERMETURE SC	1	18,20 €			
80	SRN73072	JOINT TORIQUE 107x5	1	11,50 €			
80	SRN73072	JOINT TORIQUE 107x5	1	11,50 €			
81	SRN73072	COLLECTEUR DEPART MOOREA 4	1	846,00 €			
82	SRN57737	DOIGT DE GANT	1	16,00 €			
83	SRN73072	SONDE A VISER	1	16,80 €			
83	SRN73072	SONDE A VISER	1	16,80 €			
84	SRN73072	ELECTRODE IONISATION & ALLUM	1	70,20 €			
85	SRN73072	OBTURATEUR PASSAGE BRUL.ARI	1	128,00 €			
86	SRN73072	JOINT OBTURATEUR PASSAGE BR	1	32,40 €			
87	SRN73072	ISOLANT OBTURATEUR PASSAGE	1	24,80 €			

90	SRN73072	COLLECTEUR DEPART MOOREA 4	1	305,00 €
91	SRN73072	COLLECTEUR RETOUR PLEIN MOC	1	128,00 €
92	SRN73072	JOINT TORIQUE 82x5	1	11,30 €
92	SRN73072	JOINT TORIQUE 82x5	1	11,30 €
93	SRN73072	COLLECTEUR RETOUR MOOREA 4	1	865,00 €
94	SRN68223	SECURITE MANQUE D'EAU/MOORE	1	40,90 €
95	SRN69530	VANNE DE VIDANGE	1	16,70 €
96	SRN73072	TRANSFORMATEUR D'ALLUMAGE :	1	35,80 €
97	SRN73072	PRESSOSTAT SGB 400-610 E	1	182,00 €
98	SRN73072	PRESSOSTAT DIFFERENTIEL SGB	1	93,90 €
99	SRN73072	SUPPORT PRESSOSTAT MOOREA	1	17,80 €
100	SRN73072	SUPPORT ISOLATION AVANT MOO	1	18,40 €
101	SRN73072	FIXATION TUYAUTERIE FUMEEES DI	1	20,90 €
102	SRN73072	TUYAUTERIE FUMEEES DN 250	1	398,00 €
103	SRN73072	JOINT TUYAUTERIE FUMEEES DN 25	1	61,00 €
104	SRN93692	TUYAU AVEC TE	1	13,40 €



SGB 470 E

avr-13

HABILLAGE

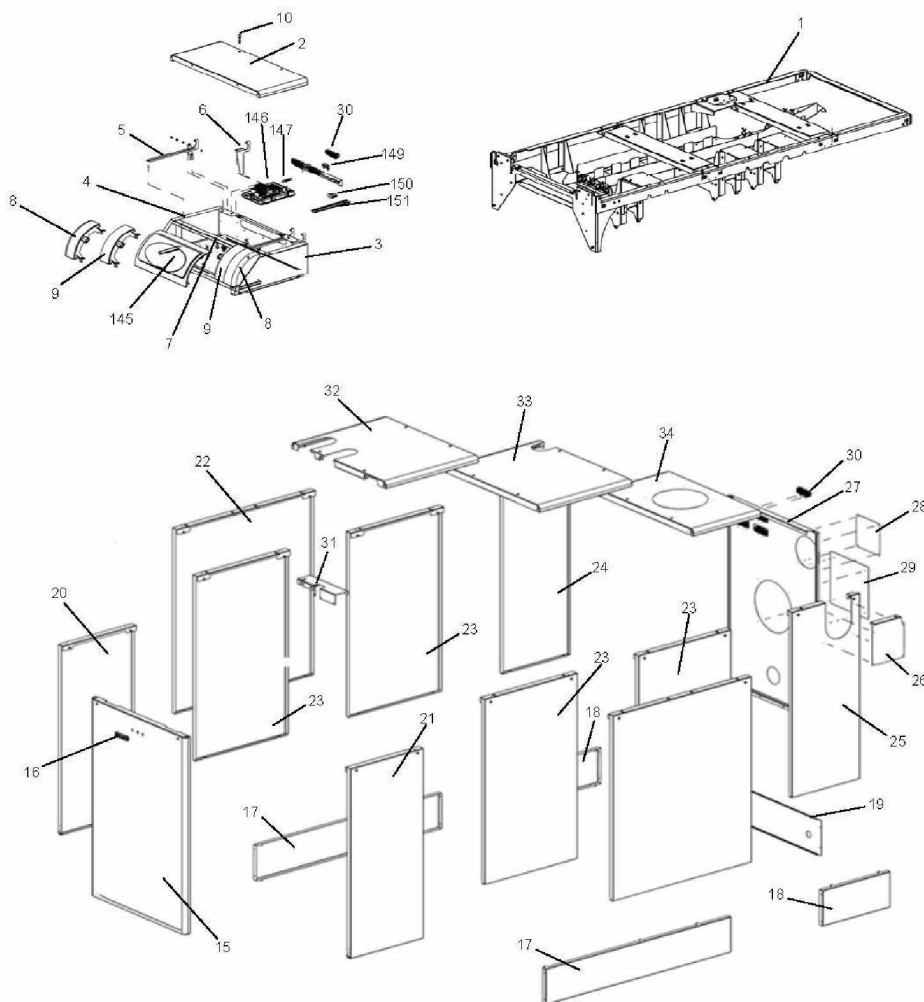

1

SGB 470 E - HABILLAGE_Vue

Réf.	Référenc	Description	Qté	Tarif	Substitut	Tarif Sub.	Remarques
1	SRN73071	CADRE SUPPORT JAQUETTE SUP.	1	1147,00 €			
2	7668873	COUVERCLE TABL.COMMANDE MC	1	52,80 €			
3	7637970	PANNEAU LAT.DROIT TABL.COMM,	1	84,90 €			
4	7637971	PANNEAU LAT.GAUCHE TABL.COM	1	84,90 €			
5	SRN73071	SUPPORT LONG COUVERCLE TAB	1	69,10 €			
6	SRN73071	SUPPORT COURT COUVERCL.TAB	1	41,30 €			
7	SRN73071	SUPPORT TRANSVERSAL COUVEF	1	110,00 €			
8	7668874	FACADE ANGLE D/G TABL.COMMAI	1	Nous consulter...			
10	SRN57889	VIS PLASTIQUE BLOQ.56MM	1	7,00 €			
15	7637972	JAQUETTE DE FACADE MOOREA 4	1	136,00 €			
16	SRN99893	LOBO/BGB	1	4,90 €			
17	7637974	JAQUETTE LAT.BASSE AVANT MOC	1	48,20 €			
18	7637975	JAQUETTE LATERALE BASSE ARRI	1	37,70 €			
19	7637976	JAQUETTE BASSE ARRIERE MOOF	1	33,20 €			
20	7637977	JAQUETTE LATERAL GAUCHE AVA	1	114,00 €			
21	7637978	JAQUETTE LATERAL DROITE AVAN	1	114,00 €			
23	7637980	JAQUETTE LAT.MILIEU MOOREA 4	1	117,00 €			
24	7637981	JAQUETTE LAT.ARRIERE GAUCHE	1	110,00 €			
25	7637982	JAQUETTE LATERALE ARRIERE DF	1	107,00 €			
26	7637983	OBTURATEUR LAT.ARRIERE ENTR	1	27,60 €			
27	7637984	JAQUETTE ARRIERE MOOREA 400	1	150,00 €			
28	7637988	OBTURATEUR ARR.ENTREE D'AIR	1	16,70 €			
29	7637989	OBTURATEUR ARR SORTIE DE FUI	1	19,20 €			
30	SRN73071	PASSE CABLE 6 PASSAGES	1	18,10 €			
31	7637990	SUPPORT COUVERCLE AVANT MO	1	21,90 €			
32	7668878	COUVERCLE AVANT MOOREA 470-	1	110,00 €			
33	7668880	COUVERCLE MILIEU MOOREA 470-	1	109,00 €			
34	7668881	COUVERCLE ARRIERE MOOREA 4(1	94,60 €			
145	7637968	CAPOT	1	48,00 €			
146	SRN73072	UNITE CENTRALE LMS14 SGB 400	1	333,00 €			
147	SRN73072	BORNE DE TERRE	1	16,50 €			
149	SRN73072	PASSE CABLE	1	12,80 €			
150	SRN73072	BORNE DE RACCORDEMENT	1	16,40 €			
151	SRN73072	RAIL DIN DE 250 MM TS35	1	18,50 €			