

500 D

**ACCESSOIRES REGULATION**

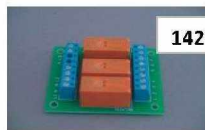
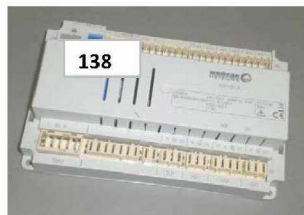
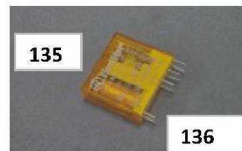
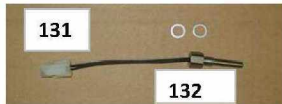
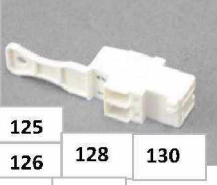
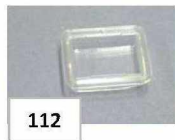
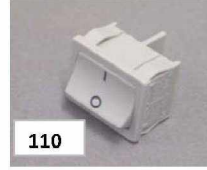
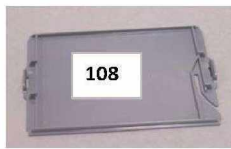
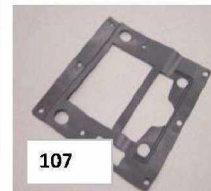
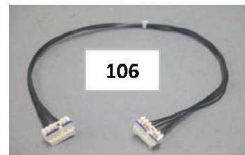

Réf.	Référenc	Description	Qté	Tarif	Substitut	Tarif Sub.	Remarques
104	SRN63593	FUSIBLE AVEC SUPPORT	1	5,50 €			
105	SRN62742	DISPLAY/AFFICHEUR UNIVERSEL	1	166,00 €			
106	SRN62744	CABLE UNITE DE COMMANDE	1	13,50 €			
107	SRN63600	JOINT	1	6,90 €			
108	SRN63601	COUVERCLE	1	7,10 €			
109	SRN62743	BOUTON ROTATIF UNITE CDE ISR	1	5,40 €			
110	SRN62740	COMMUTATEUR	1	6,60 €			
111	SRN62745	BOUTON POUSSOIR	1	8,10 €			
112	SRN63602	CAPUCHON DE PROTECT.P/INTER	1	3,60 €			
113	SRN99527	MODULE CIB P/CHAUDIERE WGB2.	1	384,00 €			
114	SRN99528	CLIP-IN RELAIS MODULE	1	419,00 €			
115	SRN99529	RELAIS MODULE CIMP	1	635,00 €			
116	SRN99530	CLIP IN MODULE DE REMPLACEME	1	159,00 €			
117	SRN99532	CLIP IN TEMPERATURE/RELAIS MC	1	159,00 €			
118	SRN63603	CLIP IN SOLAIRE MODULE REMPLA	1	205,00 €			
119	SRN62752	FICHE APPAREIL AMBIANT (RGT)	1	5,90 €			
120	SRN63604	FICHE THERMOST.D'AMB.1 (RT1)	1	5,20 €			
121	SRN63605	FICHE THERMOST.D'AMB.2 (RT2)	1	4,60 €			
122	SRN62748	CONNECTEUR 2 POLES	1	5,10 €			
123	SRN62750	CONNECTEUR SONDE E.F 2 POLES	1	5,10 €			
124	SRN62749	CONNECTEUR POUR SONDE EXTE	1	8,10 €			
125	SRN60349	FICHE BUS LPB	1	3,20 €			
126	SRN63606	CONNECTEUR CONTROLEUR DE C	1	4,60 €			
127	SRN64137	FICHE CONNECTION P/REGUL.LML	1	16,40 €			
128	SRN60351	CONNECTEUR ENTREE CLIP IN	1	3,30 €			
129	SRN60347	CONNECTEUR ENTREE CLIP IN	1	3,30 €			
130	SRN60352	CONNECTEUR SORTIE 3 POLES CI	1	3,90 €			
131	SRN98656	SONDE CHAUDIERE QAK36 HAUTE	1	24,60 €			
132	SRN63607	JOINT POUR SONDE DE DEPART W	1	4,90 €			
133	SRN62747	FICHE BRUL.2A / RAST 5-7 POLES	1	5,10 €			
134	SRN97282	SONDE EXTERIEURE QAC34	1	22,20 €			
135	SRN64439	RELAIS SGB 320-500	1	26,10 €			
136	SRN64440	SOCLE DE RELAIS 320-500	1	28,50 €			
137	SRN65651	CARTE LMU 74	1	338,00 €			
138	SRN65660	MODULE ISR BCA (RVS46.543)	1				
140	SRN63592	COUVERCLE LMU	1	20,90 €			
141	SRN64331	ELEMENT INF.DU BOITIER LMU	1	33,00 €			

500 D

	<b>ACCESSOIRES</b>	
--	--------------------	--

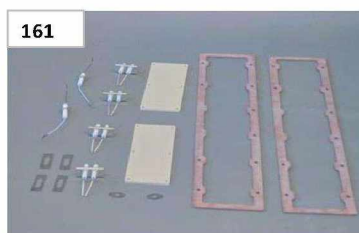
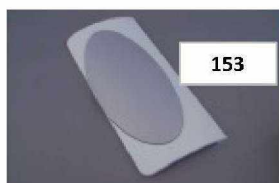

1

MOOREA 500 D- ACCESSOIRES\_Vue

Réf.	Référenc	Description	Qté	Tarif	Substitut	Tarif Sub.	Remarques
150	SRN61009	JOINT POUR BRIDE RACCORD	1	18,10 €			
151	SRN62003	PIECE LATERALE PLASTIQUE SOB	1	46,20 €			
152	SRN64327	PIECE INTER.TABLEAU COMMAND	1	56,70 €			
153	SRN62001	COUVERCLE TABLEAU SOB	1	33,10 €			
154	SRN57696	THERMOSTAT SECURITE RAK 77-1	1	89,80 €			
155	SRN97278	TRANSFORMATEUR ALLUMAGE	1				
156	SRN98634	CABLE D'ALLUMAGE WGB2.15/2.38	1	15,70 €			
157	SRN99120	TRANSFORMATEUR D'ALLUMAGE	1	146,00 €			
158	SRN99121	CABLE D'ALLUMAGE WGB2(N)50.70	1	22,50 €			
159	SRN56203	CONTROLEUR SECURITE D'EAU 1/	1	55,30 €			
160	SRN93669	JOINT 10/15X1,5 P/CONTROLEUR D	1	5,10 €			

1

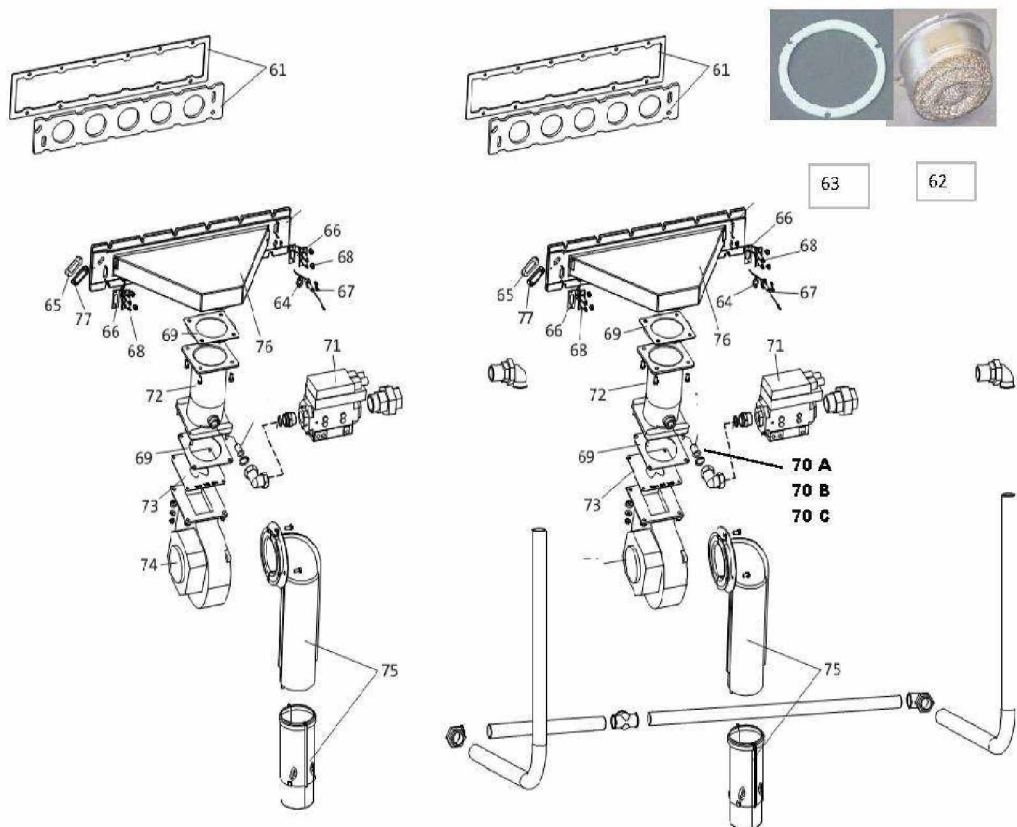

BRULEUR

500 D

MOOREA 500 D-BRULEUR\_Vue

Réf.	Référence	Description	Qté	Tarif	Substitut	Tarif Sub.	Remarques
61	SRN62437	SACHET DE JOINTS POUR BRULEL	1	84,40 €			
61	SRN62437	SACHET DE JOINTS POUR BRULEL	1	84,40 €			
62	SRN65425	FURINIT BRULEUR	1	82,20 €			
63	SRN62438	JOINT TUBE BRULEUR SGB 90/500I	1	6,30 €			
64	SRN93672	JOINT IONISATION SGB	1	3,90 €			
64	SRN93672	JOINT IONISATION SGB	1	3,90 €			
65	SRN93673	JOINT VERRE VISEUR SGB	1	4,90 €			
66	SRN93674	JOINT D'UNITE D'ALLUMAGE/SGB	1	5,50 €			
66	SRN93674	JOINT D'UNITE D'ALLUMAGE/SGB	1	5,50 €			
66	SRN93674	JOINT D'UNITE D'ALLUMAGE/SGB	1	5,50 €			
66	SRN93674	JOINT D'UNITE D'ALLUMAGE/SGB	1	5,50 €			
67	SRN65426	ELECTRODE D'ALLUMAGE	1	55,30 €			
67	SRN65426	ELECTRODE D'ALLUMAGE	1	55,30 €			
68	SRN65427	ELECTRODE D'IONISATION	1	39,50 €			
68	SRN65427	ELECTRODE D'IONISATION	1	39,50 €			
68	SRN65427	ELECTRODE D'IONISATION	1	39,50 €			
68	SRN65427	ELECTRODE D'IONISATION	1	39,50 €			
69	SRN95910	JOINT VENTILATEUR SGB160.250	1	22,40 €			
69	SRN95910	JOINT VENTILATEUR SGB160.250	1	22,40 €			
69	SRN95910	JOINT VENTILATEUR SGB160.250	1	22,40 €			
69	SRN95910	JOINT VENTILATEUR SGB160.250	1	22,40 €			
70A	SRN65648	INJECTEUR GAZ 15MM SGB 250 C/I	1	8,60 €			
70B	SRN65649	INJECTEUR GAZ 13,50MM SGB 250	1	31,40 €			
70C	SRN62150	INJECTEUR GAZ 10MM SGB 250 C/I	1	8,50 €			
71	SRN99707	VANNE P/CHAUD.SGB 2.250	1	1877,00 €			
71	SRN99707	VANNE P/CHAUD.SGB 2.250	1	1877,00 €			
72	SRN62444	TUBE DE MELANGE	1	223,00 €			
72	SRN62444	TUBE DE MELANGE	1	223,00 €			
73	SRN64337	DIAPHRAGME SGB 250D	1	8,80 €			
73	SRN64337	DIAPHRAGME SGB 250D	1	8,80 €			
74	SRN99710	VENTILATEUR P/SGB 2.160/250 Tyj	1	1686,00 €			
76	SRN62443	CANAL DE MELANGE (ALU) SGB250	1	808,00 €			
76	SRN62443	CANAL DE MELANGE (ALU) SGB250	1	808,00 €			
77	SRN93699	VOYANT DE FLAMME	1	25,80 €			

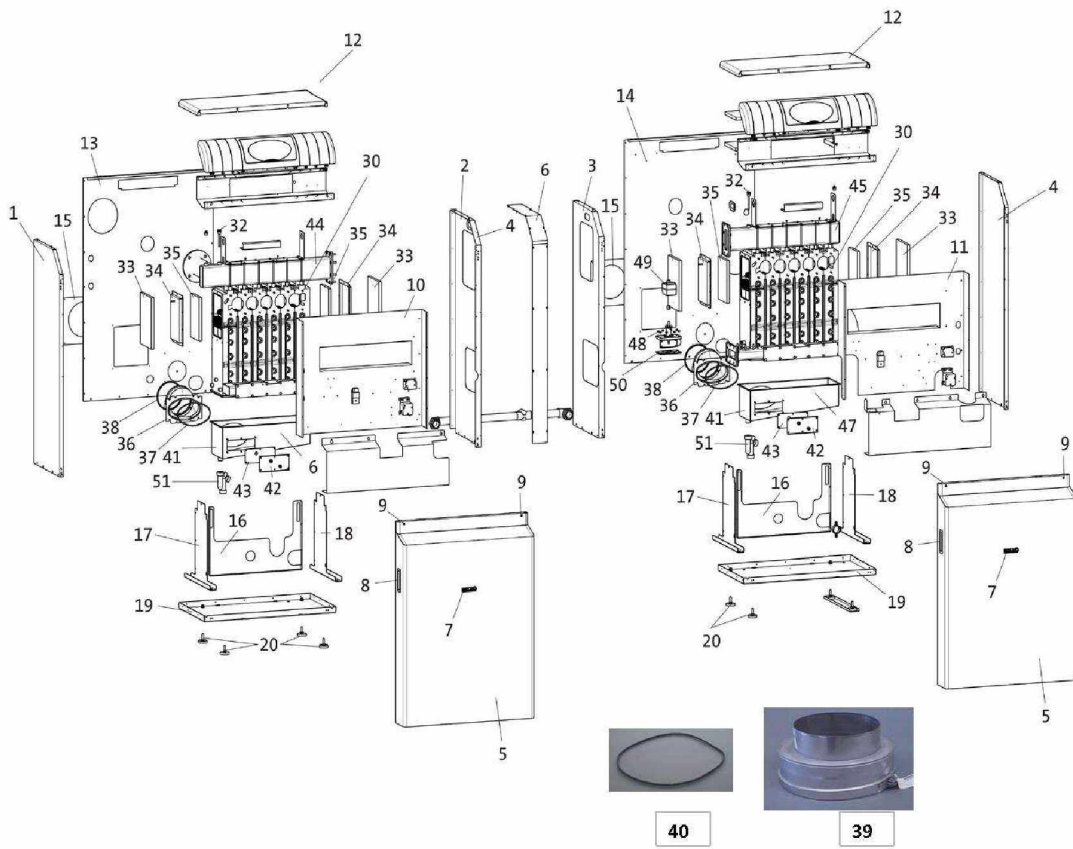

MOOREA 500 D- HABILLAGE\_Vue

HABILLAGE ET CORPS DE CHAUFFE

500 D

Réf.	Référence	Description	Qté	Tarif	Substitut	Tarif Sub.	Remarques
5	SRN64382	PANNEAU AVANT SGB.500	1	514,00 €			
5	SRN64382	PANNEAU AVANT SGB.500	1	514,00 €			
7	SRN99893	LOBO/BGB	1	4,90 €			
7	SRN99893	LOBO/BGB	1	4,90 €			
8	SRN99894	POIGNEE SGB 90-205 D	1	5,30 €			
8	SRN99894	POIGNEE SGB 90-205 D	1	5,30 €			
9	SRN64808	VISSERIE CAPOT	1	24,00 €			
9	SRN64808	VISSERIE CAPOT	1	24,00 €			
9	SRN64808	VISSERIE CAPOT	1	24,00 €			
9	SRN64808	VISSERIE CAPOT	1	24,00 €			
17	SRN64404	PIED GAUCHE /SGB320-500	1	193,00 €			
17	SRN64404	PIED GAUCHE /SGB320-500	1	193,00 €			
20	SRN93645	PIED POUR SGB320-500 KW	1	39,50 €			
20	SRN93645	PIED POUR SGB320-500 KW	1	39,50 €			
30	SRN64307	ECHANGEUR THERMIQUE SGB250	1	11137,00 €			
30	SRN64307	ECHANGEUR THERMIQUE SGB250	1	11137,00 €			
32	SRN57737	DOIGT DE GANT	1	16,00 €			
32	SRN57737	DOIGT DE GANT	1	16,00 €			
33	SRN93632	COUVERCLE ECHANGEUR TYPE9C	1	280,00 €			
33	SRN93632	COUVERCLE ECHANGEUR TYPE9C	1	280,00 €			
33	SRN93632	COUVERCLE ECHANGEUR TYPE9C	1	280,00 €			
33	SRN93632	COUVERCLE ECHANGEUR TYPE9C	1	280,00 €			
34	SRN93643	PLAQUE PROTECTION PHONIQUE	1	41,50 €			
34	SRN93643	PLAQUE PROTECTION PHONIQUE	1	41,50 €			
34	SRN93643	PLAQUE PROTECTION PHONIQUE	1	41,50 €			
34	SRN93643	PLAQUE PROTECTION PHONIQUE	1	41,50 €			
35	SRN93644	PLAQUE PROTECTION PHONIQUE	1	69,00 €			
35	SRN93644	PLAQUE PROTECTION PHONIQUE	1	69,00 €			
35	SRN93644	PLAQUE PROTECTION PHONIQUE	1	69,00 €			
35	SRN93644	PLAQUE PROTECTION PHONIQUE	1	69,00 €			
36	SRN95890	BUSE GAZ DE FUMEE SGB160-250	1	333,00 €			
37	SRN99746	JOINT BAC CONDENS.SGB 160D-25C	1	13,40 €			
37	SRN99746	JOINT BAC CONDENS.SGB 160D-25C	1	13,40 €			
38	SRN95891	JOINT PROFI.DN180 P/SGB160-250	1	29,50 €			
38	SRN95891	JOINT PROFI.DN180 P/SGB160-250	1	29,50 €			
40	SRN60990	JOINT DN250 POUR GAZ DE FUMEE	1	67,40 €			
41	SRN97836	COLLECTEUR GAZ DE FUMEE SGB	1	812,00 €			
41	SRN97836	COLLECTEUR GAZ DE FUMEE SGB	1	812,00 €			
42	SRN93630	COUVERCLE NETTOYAGE GAZ DE	1	17,10 €			
42	SRN93630	COUVERCLE NETTOYAGE GAZ DE	1	17,10 €			
43	SRN93671	JOINT POUR CAISSON DE FUMEE	1	33,10 €			
43	SRN93671	JOINT POUR CAISSON DE FUMEE	1	33,10 €			
48	SRN64413	CLAPET	1	240,00 €			
50	SRN64414	JOINT	1	7,70 €			
51	SRN57756	SIPHON EAU CONDENS.A/TUBE CF	1	32,20 €			
51	SRN57756	SIPHON EAU CONDENS.A/TUBE CF	1	32,20 €			