

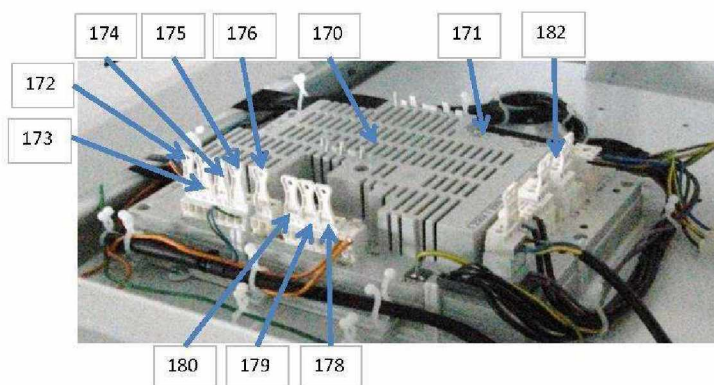

SGB 400-470-540-610 E

	ACCESSOIRES	
--	-------------	--

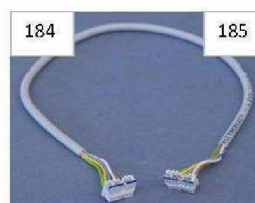

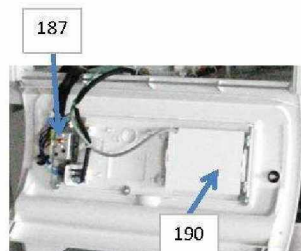
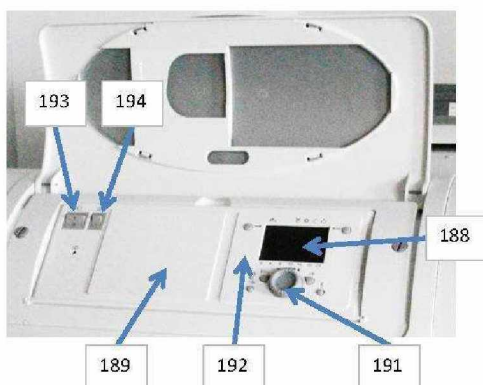

## SGB 400-610 E

## SGB 470 E

Réf.	Référenc	Description	Qté	Tarif	Substitut	Tarif Sub.	Remarques
18	7714237	CABLAGE SGB 400-610 i	1	137,00 €			
170	SRN68148	CARTER PLATINE	1	17,00 €			
171	SRN63593	FUSIBLE AVEC SUPPORT	1	5,50 €			
172	SRN68150	CONNECTEUR H5	1	5,00 €			
173	SRN68151	CONNECTEUR H4	1	5,00 €			
174	SRN68152	CONNECTEUR UH	1	5,00 €			
175	SRN68153	CONNECTEUR H1	1	5,00 €			
176	SRN62749	CONNECTEUR POUR SONDE EXTE	1	8,10 €			
178	SRN67137	DOUILLE RAST5 02K09 BX3	1	4,10 €			
179	SRN67138	DOUILLE RAST5 02K09 BX2	1	4,10 €			
180	SRN67139	DOUILLE RAST5 02K09 BX1	1	4,10 €			
182	SRN64137	FICHE CONNECTION P/REGUL.LML	1	16,40 €			
184	SRN65662	CABLE BUS UNITE DE CDE LG430M	1	10,20 €			
185	SRN69588	CABLE BUS UNITE DE CDE LG570M	1	12,10 €			
187	SRN73073	THERMOSTAT DE SECURITE STB 1	1				
188	SRN81154	DISPLAY/AFFICHEUR UNIVERSEL	1	166,00 €			
190	SRN68138	CARENAGE UNITE DE COMMANDE	1	10,90 €			
191	SRN62743	BOUTON ROTATIF UNITE CDE ISR	1	5,40 €			
192	SRN68823	BOUCHON CAOUTCHOUC CONNEC	1	3,20 €			
193	SRN62740	COMMUTATEUR	1	6,60 €			
194	SRN62745	BOUTON POUSSOIR	1	8,10 €			
195	SRN73073	KIT D'ENTRETIEN SGB 400 E	1				[To Translat = ]
195	7307345	KIT D ENTRETIEN / SGB 470E	0				
195	7307346	KIT ENTRETIEN SGB 540 E	0	291,00 €			
195	7307347	SET ENTRETIEN SGB 610 E	0				
196	SRN73073	KIT JOINT D'ENTRETIEN SGB E 400	1	214,00 €			[To Translat = ]



SGB 470 H.T.E

	<b>BRULEUR</b>	
--	----------------	--

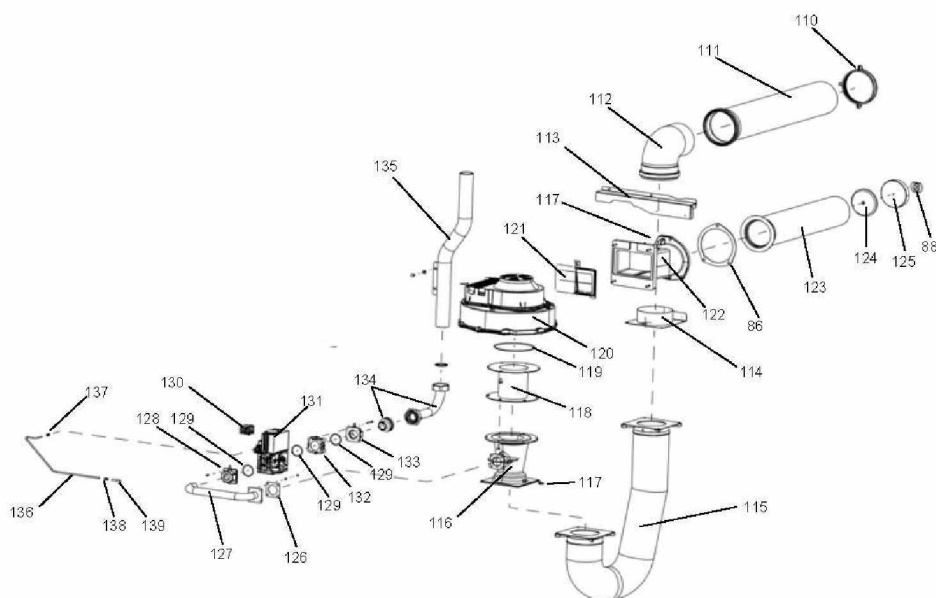



## SGB 400-610 E

## SGB 470 E

Réf.	Référenc	Description	Qté	Tarif	Substitut	Tarif Sub.	Remarques
86	SRN73072	JOINT OBTURATEUR PASSAGE BR	1	32,40 €			
88	SRN73072	CLIP DE MAINTIEN ISOLANT OBTU	1	18,60 €			
117	SRN73072	PRISE DE PRESSION R1/8"	1	12,60 €			
117	SRN73072	PRISE DE PRESSION R1/8"	1	12,60 €			
119	SRN73072	JOINT TORIQUE 180X3,5	1	13,10 €			
120	SRN73072	VENTILATEUR TYPE G3G250GN442	1	2165,00 €			
121	SRN73072	CLAPET D'AIR SGB 400-610 E	1	97,00 €			
124	SRN73072	PLAQUE ISOLANTE TUBE BRULEUI	1	33,40 €			
125	SRN73072	CAPUCHON TUBE BRULEUR SGB 4	1	56,50 €			
126	SRN73072	JOINT-VENTURI TUBE GAZ SGB 40	1	19,80 €			
128	SRN82306	BRIDE SORTIE VANNE GAZ SGB 40	1	37,60 €			
129	SRN73072	JOINT TORIQUE 52x3,5	1	10,20 €			
129	SRN73072	JOINT TORIQUE 52x3,5	1	10,20 €			
129	SRN73072	JOINT TORIQUE 52x3,5	1	10,20 €			
130	SRN73072	PRESSOSTAT GAZ SGB 400-540 E	1	92,40 €			
131	SRN73072	VANNE GAZ TYPE VR434VE5021 SC	1	1505,00 €			
132	SRN73072	FILTRE GAZ SGB 400-540 E	1	63,20 €			
133	SRN82311	BRIDE ENTREE VANNE GAZ SGB 40	1	51,30 €			
134	SRN73072	FLEXIBLE GAZ SGB 400-540 E	1	415,00 €			
136	SRN73072	TUBE RILSAN 6x1 MM	1	16,50 €			
137	SRN73072	RACCORD TUBE RILSAN-VANNE G	1	21,10 €			
138	SRN73072	RACCORD TUBE RILSAN-VANNE G	1	21,10 €			
139	SRN73072	ADAPTATEUR 1/8"-M5 SGB 400-540	1	72,10 €			



SGB 470 E

nov-12

	<b>CORPS DE CHAUFFE</b>	
--	-------------------------	--

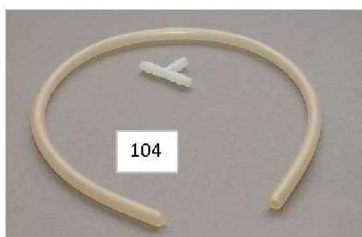
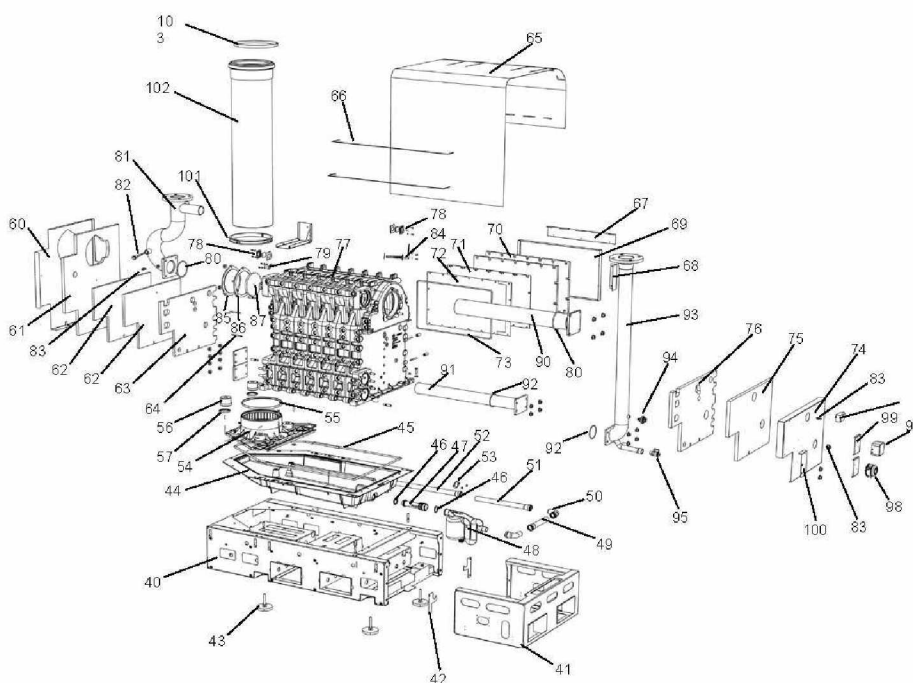

1

SGB 470 E - CORPS DE CHAUFFE\_Vue

Réf.	Référenc	Description	Qté	Tarif	Substitut	Tarif Sub.	Remarques
55	SRN73071	JOINT ADAPTATEUR SORTIE FUME	1	10,60 €			
56	SRN73071	BOUCHON DE REMPLISSAGE BAC	1	20,00 €			
57	SRN73071	JOINT BOUCHON DE REMPLISSAG	1	70,60 €			
78	SRN73072	ENSEMBLE VISEUR DE FLAMME SC	1	17,30 €			
78	SRN73072	ENSEMBLE VISEUR DE FLAMME SC	1	17,30 €			
79	SRN73072	TOLE ET JOINT DE FERMETURE SC	1	18,20 €			
80	SRN73072	JOINT TORIQUE 107x5	1	11,50 €			
80	SRN73072	JOINT TORIQUE 107x5	1	11,50 €			
82	SRN57737	DOIGT DE GANT	1	16,00 €			
83	SRN73072	SONDE A VISER	1	16,80 €			
83	SRN73072	SONDE A VISER	1	16,80 €			
83	SRN73072	SONDE A VISER	1	16,80 €			
84	SRN73072	ELECTRODE IONISATION & ALLUM	1	70,20 €			
86	SRN73072	JOINT OBTURATEUR PASSAGE BR	1	32,40 €			
87	SRN73072	ISOLANT OBTURATEUR PASSAGE	1	24,80 €			
92	SRN73072	JOINT TORIQUE 82x5	1	11,30 €			
92	SRN73072	JOINT TORIQUE 82x5	1	11,30 €			
94	SRN68223	SECURITE MANQUE D'EAU/MOORE	1	40,90 €			
95	SRN69530	VANNE DE VIDANGE	1	16,70 €			
96	SRN73072	TRANSFORMATEUR D'ALLUMAGE :	1	35,80 €			
97	SRN73072	PRESSOSTAT SGB 400-610 E	1	182,00 €			
98	SRN73072	PRESSOSTAT DIFFERENTIEL SGB	1	93,90 €			
103	SRN73072	JOINT TUYAUTERIE FUMEES DN 25	1	61,00 €			
104	SRN93692	TUYAU AVEC TE	1	13,40 €			





SGB 470 E

avr-13

HABILLAGE

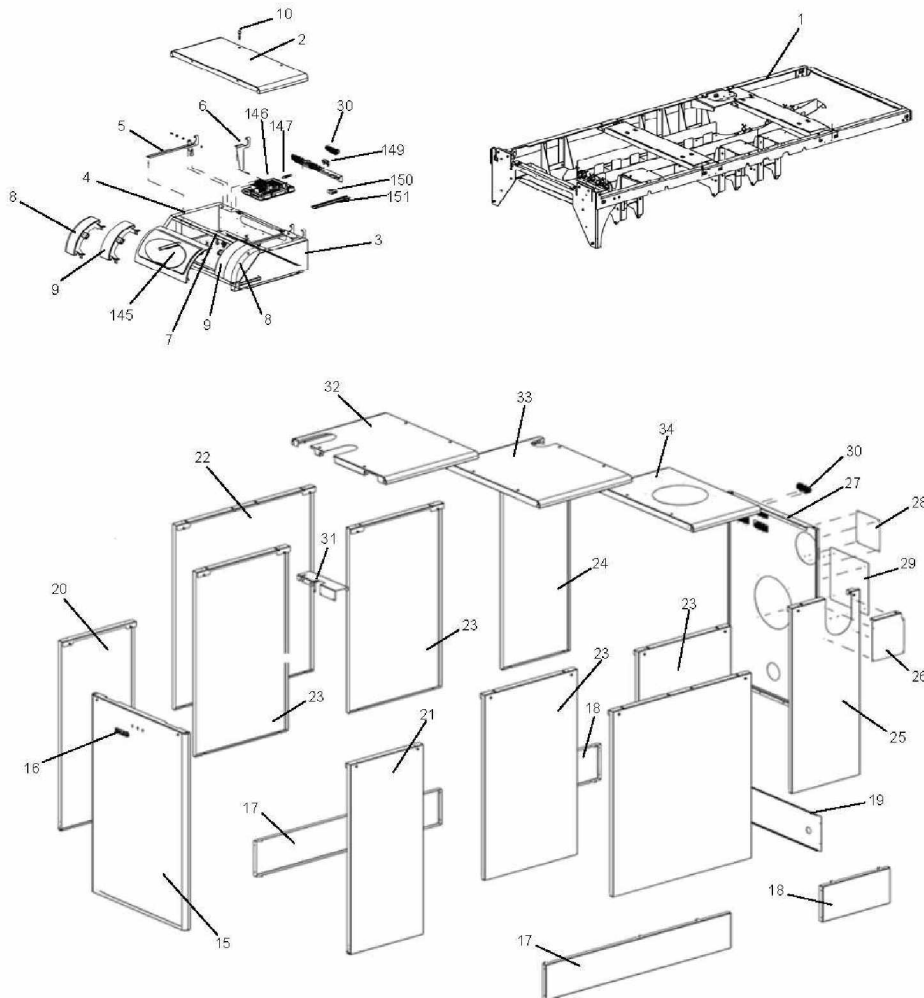

1

SGB 470 E - HABILLAGE\_Vue



SGB 400-610 E

SGB 470 E

Réf.	Référenc	Description	Qté	Tarif	Substitut	Tarif Sub.	Remarques
8	SRN62003	PIECE LATERALE PLASTIQUE SOB	1	46,20 €			
8	SRN62003	PIECE LATERALE PLASTIQUE SOB	1	46,20 €			
9	SRN64327	PIECE INTER.TABLEAU COMMAND	1	56,70 €			
9	SRN64327	PIECE INTER.TABLEAU COMMAND	1	56,70 €			
10	SRN57889	VIS PLASTIQUE BLOQ.56MM	1	7,00 €			
16	SRN99893	LOBO/BGB	1	4,90 €			
145	SRN62001	COUVERCLE TABLEAU SOB	1	33,10 €			
146	7642558	PLATINE LMS 14 SGB	1				