

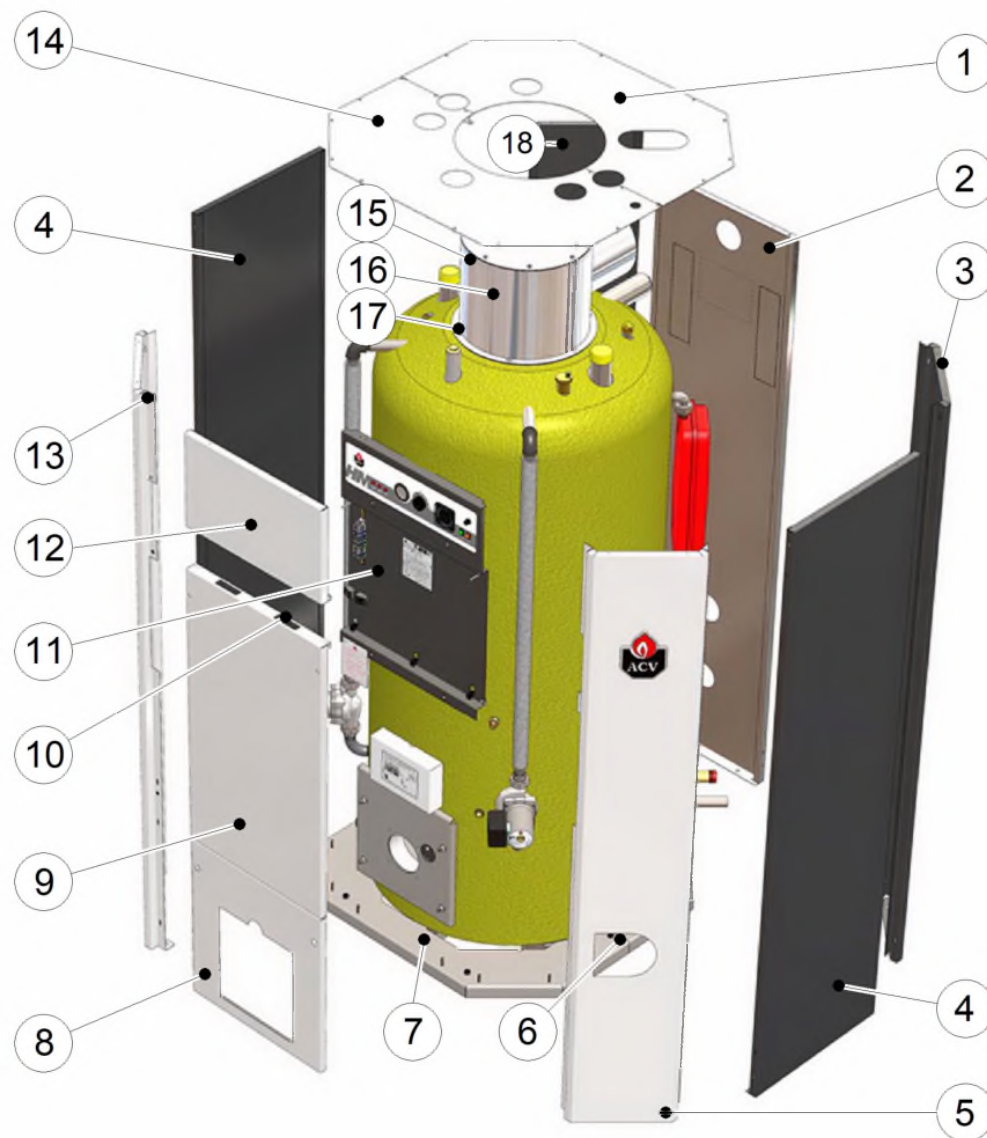

## Panels HM200N V13





Panels HM200N V13





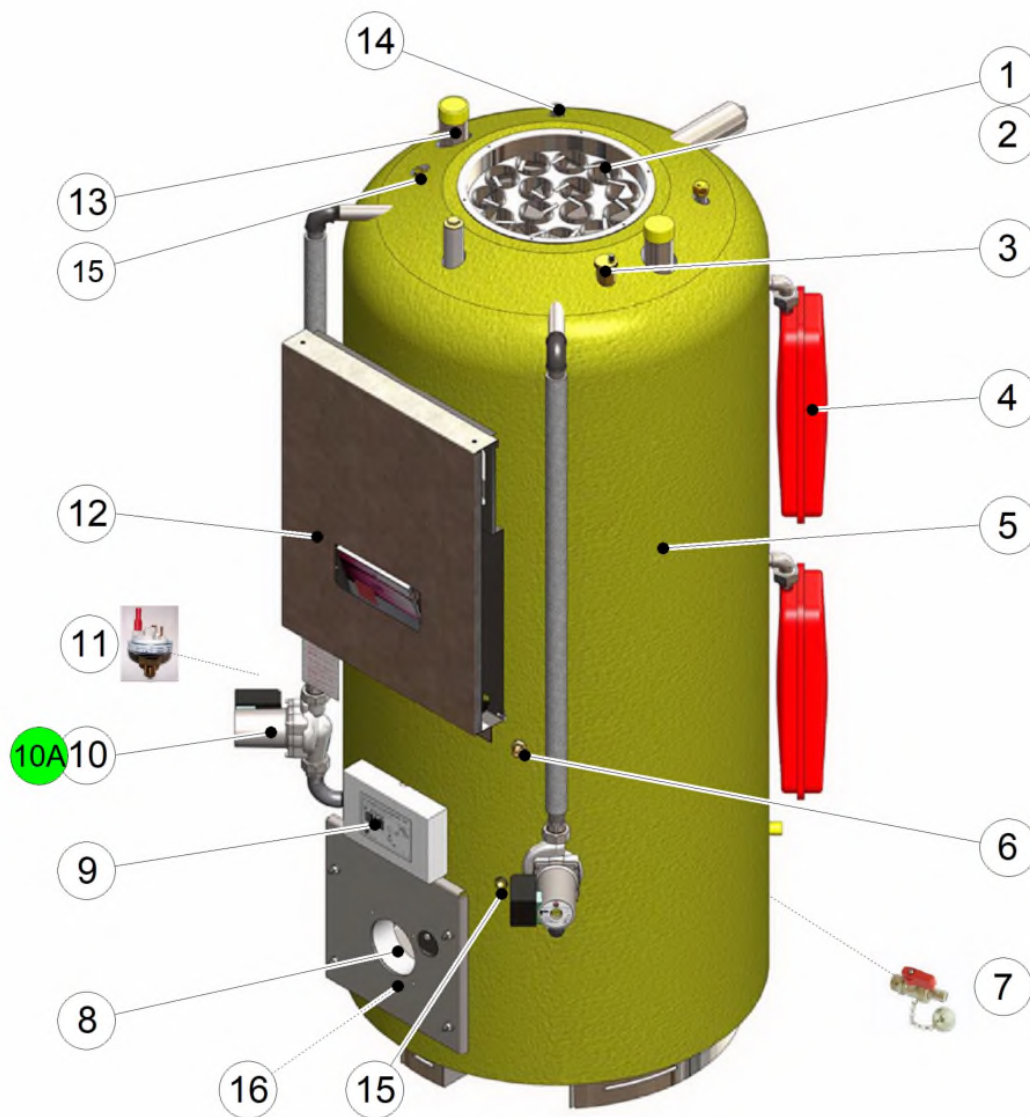









Code	Code GA	Quant.	Picture	Description	From --- To ----
1	21475505	1		Top panel rear HM200-201 (white V13)	01-01-14-
2	20474505	1		Rear panel HM200-201 (galva V13)	01-01-14-
3	21478505	1		Corner panel rear RH HM200-201 (Grey)	01-01-14-
4	21471505	784568	2	Side panel LH&RH HM200-201 (grey V13)	01-01-14-
5	21472505	784588	1	Corner panel front RH HM200-201 whiteV13	01-01-14-
6	21480024	784695	2	Junction base plates J800-1000 & HM200	01-01-14-
7	21475415	785733	2	Base plate HM201-200F-200N (half)	01-01-14-
8	21476505	1		Burner door cover HM200 (White V13)	01-01-14-
9	2147B505	785713	1	Front panel lower HM200-201 (white V13)	01-01-14-
10	49410280	784904	2	 Handle for cover (HD PE)	01-01-14-
11	21477415	1		Control panel (plate) HM200	01-01-14-
12	2147A505	1		Front panel upper HM200-201 (white V13)	01-01-14-
13	21479505	784694	1	Corner panel front LH HM200-201 whiteV13	01-01-14-
14	21475506	1		Top panel front HM200-201 (white V13)	01-01-14-
15	557A0157	786631	1	Gasket upper flue box HM200-201 380/320	01-01-14-
16	507F3044	785942	1	Flue hood horiz.HM200-201	01-01-14-
17	557A0158	786632	1	 Gasket lower flue box HM200-201 410/376	01-01-14-
18	21473415	1		Corner panel rear LH HM200-201 (Grey)	01-01-14-

Internal HM200N V13





Internal HM200N V13

Code	Code GA	Quant.	Picture	Description	From --- To ----	Remark
1	507F2009	785930	15	 Turbulator upper HM type A	01-01-14-	
2	507F2010	785931	30	 Turbulator lower HM type B	01-01-14-	HM200N
2A	507F2010	785931	15	 Turbulator lower HM type B	01-01-14-	HM115N
3	557A3001	786695	1	 Air vent auto.1/2 brass	01-01-14-	
4	55301200	785263	4	 Exp.vessel 8L.(long shape)	01-01-14-	
5	27300088		1	Body+accessories HM200N	01-01-14-	
5	30540466	784801	1	 Body foamed HM200-201	01-01-14-	
6	557A5005	786717	1	 Check valve for Manometer 1/4	01-01-14-	
7	557A1000	786653	1	Drain cock 3/4	01-01-14-	
8	51700104	784997	1	 Insul.burner door HM200	01-01-14-	
9	557A1070	786680	1	 Safety valve 3bar 247kW 3/4	01-01-14-	
10	557A4025	786707	2	 Pump Top-S 25/7 L180 G6/4 grey	01-01-14-31-07-15	non ERP
10A	A1006377	780157	2	Assembly UPML 25-105 L180 G1.5&Connector	29-10-19-	ERP Prev : A1002169
11	A1003191	787140	1	 Kit pressure switch 220V (prev: 557a1056)	01-08-16-	
12	2147E415		1	Protecting plate for controls HM200-201	01-01-14-	
13	497B0502	785869	1	Sparge tube PVCc 50x1300 unplug.	01-01-14-	
14	39438030	784822	1	 Dry well SST 1/2x1300	01-01-14-	
15	63438001	785296	2	 Dry well brass 1/2x100 3 bulbs	01-01-14-	
16	51700025	784980	1	 Cord D:10mm (per meter)	01-01-14-	

Control panel HM200N

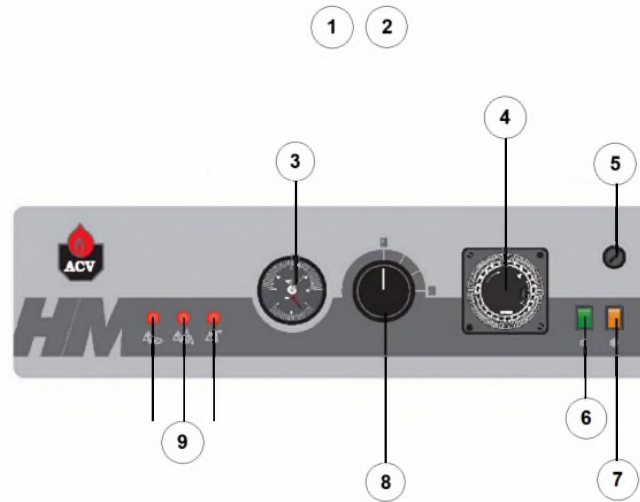





Control panel HM200N

Code	Code GA	Quant.	Picture	Description	From --- To ----	Remark	
1	24614211	784721	1		Contr.pan.cpl HM200 (V13)	01-01-14-	prev: 24614132
2	21477415		1		Control panel (plate) HM200		
3	025007		1		Combined T°/Manometer 0-4 bar 0-120°C		Prev : 54441008 -Tableau électrique
3	557A5005	786717	1		Check valve for Manometer 1/4		
4	54452000	785178	1		Timer Grässlin with switch		
5	54764006	785207	1		T-stat+reset 103°C cap3060bulb6 TS-RM-DT		
6	54766016	785234	1		Switch 2P green		
7	54766017	785235	1		Switch 2P yellow		
8	025006		1		T-stat 0-90°C cap1500 bulb6 TU-L-DT		Prev : 54442045 - Tableau électrique
8	54764021	785212	1		Knob for T-stat, white line		
9	54766001	785226	3		Light red D10 230V		
10	63438001	785296	1		Dry well brass 1/2x100 3 bulbs		
11	497B0502	785869	1		Sparge tube PVCc 50x1300 unplug.		
12	39438030	784822	1		Dry well SST 1/2x1300		
13	557A1000	786653	1		Drain cock 3/4		
14	54764022	785213	1		T-stat 0-90°C set40°C cap3000 TR 2		
15	51700025	784980	1		Cord D:10mm (per meter)		
16	49410280	784904	2		Handle for cover (HD PE)		
17	557A0158	786632	1		Gasket lower flue box HM200- 201 410/376	01-10-12-	Prev: 557A0055
18	507F3044	785942	1		Flue hood horiz.HM200- 201		



Control panel HM200N

Code	Code GA	Quant.	Picture	Description	From --- To ----	Remark	
18	557A0157	786631	1		Gasket upper flue box HM200- 201 380/320	01-10-12-	Prev: 557A0059
19	507F3019	785934	1		Flue hood HM150- 200- 201 vertical		
20	51700104	784997	1		Insul.burner door HM200	01-10-12-	Prev: 51700046
21	A1003191	787140	1		Kit pressure switch 220V (prev: 557a1056)	01-08-16-	