

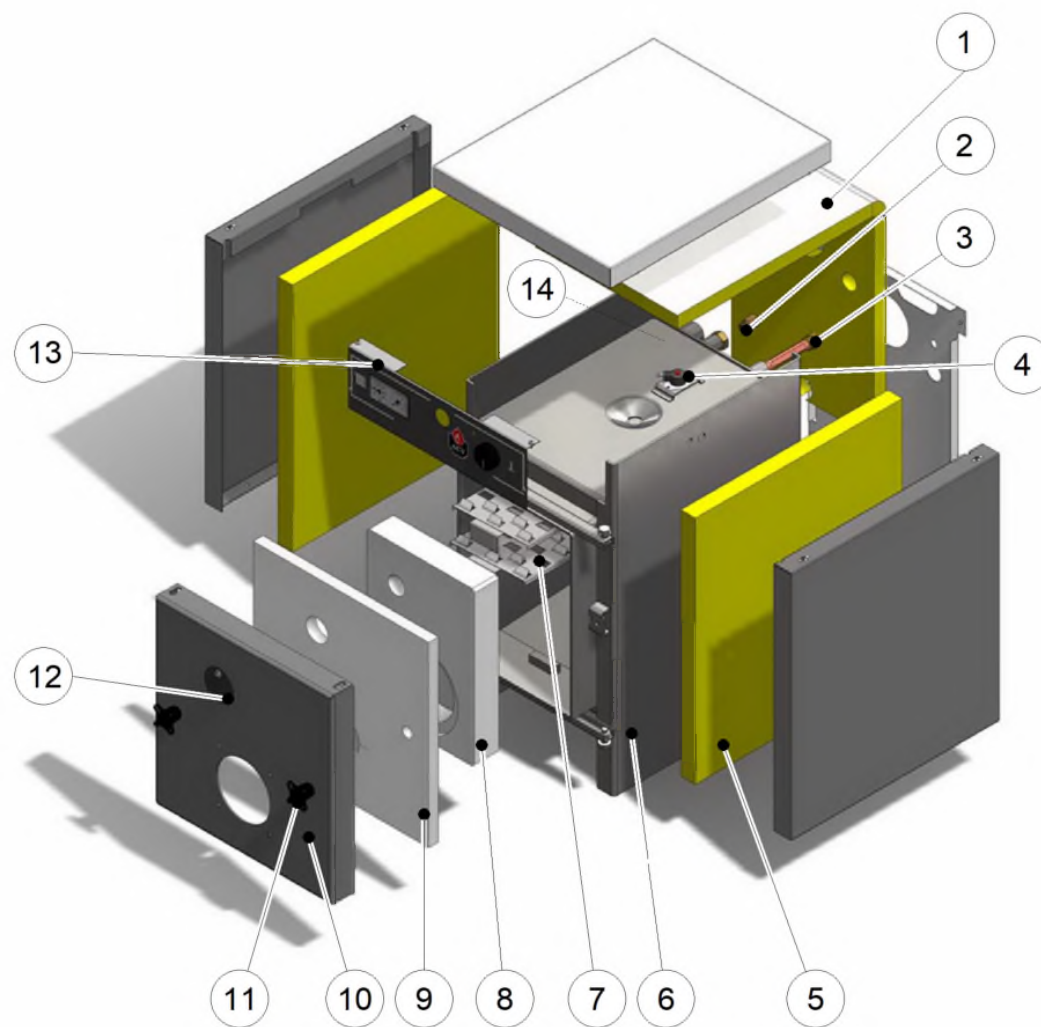









Internal N-mini V13





Internal N-mini V13

	Code	Code GA	Quant.	Photo	Description	De --- A ---
1	51702012		1		Isolation arr. et sup. N-mini	01-11-13-
2	557A5005	786717	1		Raccord manomètre 1/4 +clap.AR	01-11-13-
3	63438001	785296	1		Doigt de gant laiton 1/2x100 3 bulbes	01-11-13-
4	54442015	785171	1		T.O.D. max. 103 ° C	01-11-13-
5	51702013		2		Isolation latérale. N-mini	01-11-13-
6	30465160		1		Corps nu N-mini (ACV Nerderland)	01-11-13-
7	50423098	784915	2		Chicane N/BNE3 L.327xlarg. 188mm	01-11-13-
8	51701000	785021	1		Brique avant N-mini	01-11-13-
9	51700033	784981	1		Isol.porte N-mini cerablanquet 370x364x20	01-11-13-
10	2147P371		1		Porte brûleur N-Mini	01-11-13-
11	47405137	784865	2		Manette M10x30 blocage porte	01-11-13-
12	50423008	784907	1		Regard de flamme Alfa (noir)	01-11-13-
13	24614221		1		Tableau cpl N-mini (V13)	01-11-13-
14	54442027	785172	1		T.O.D. min. 45 °C	01-11-13-

Panels N-mini V13

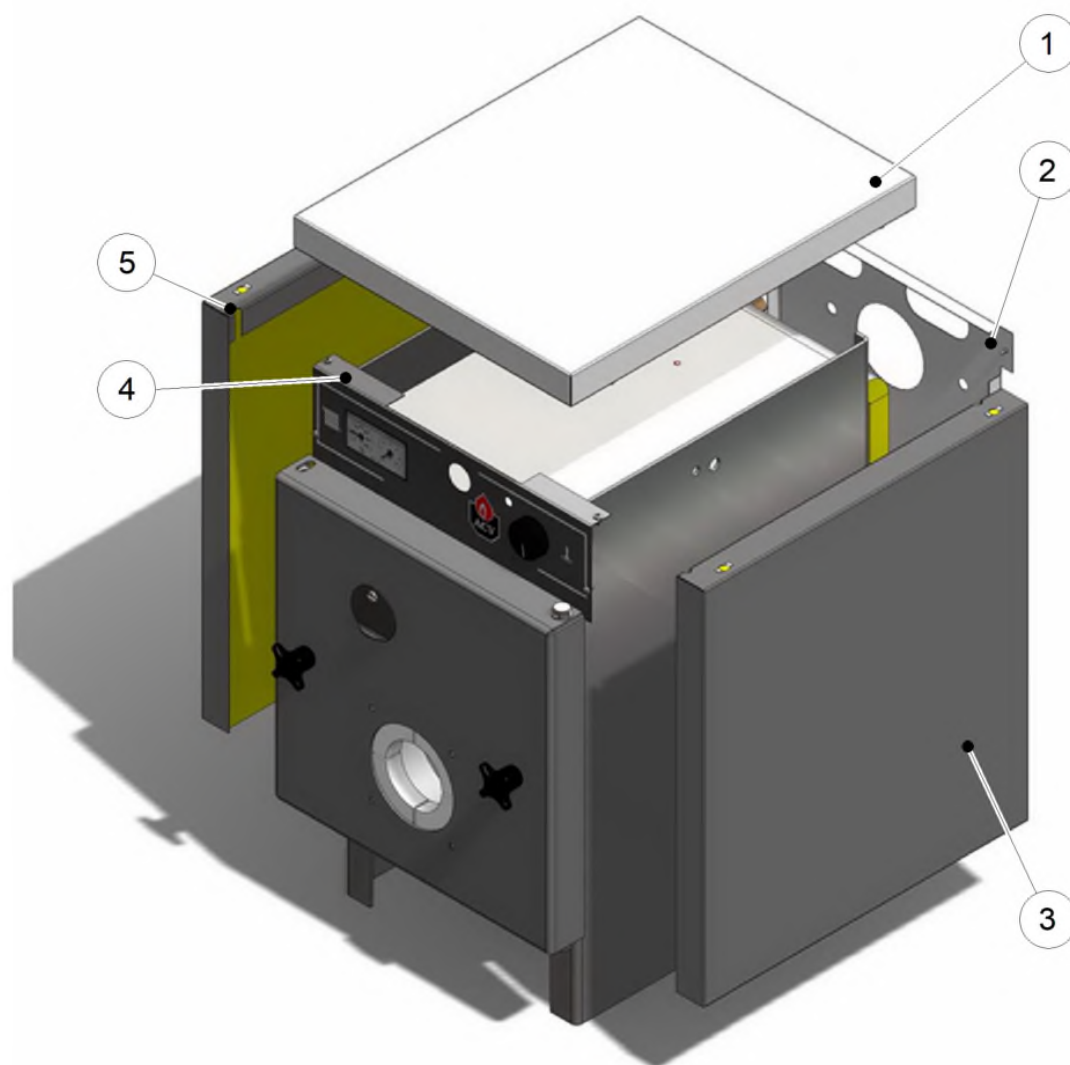



Panels N-mini V13

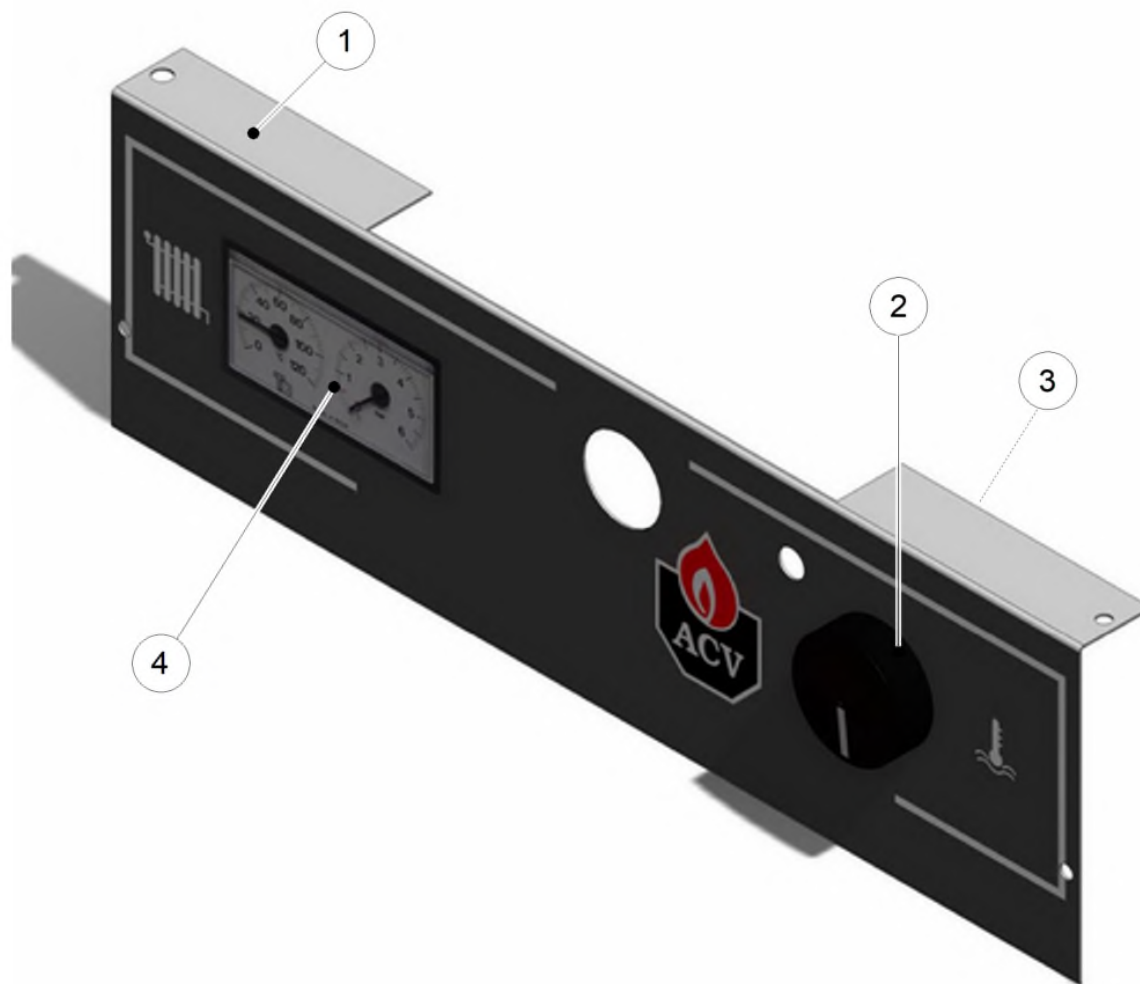

	Code	Code GA	Quant.	Description	De --- A ---
1	21475510	784645	1	Couvercle N-mini (blanc V13)	01-11-13-
2	20474510		1	Arrière N-mini (galva V13)	01-11-13-
3	21471510		1	Lat.droit N-mini (gris V13)	01-11-13-
4	21477510		1	Avant tabl. N-mini V13	01-11-13-
5	21472510	784590	1	Lat.gauche N-mini (gris V13)	01-11-13-

Control panel N-mini V13





Control panel N-mini V13

Id	Code	Code GA	Quant.	Photo	Description	De --- A ---	Remarque
1	24614221		1		Tableau cpl N-mini (V13)	01-11-13-	
2	54764021	785212	1		Bouton rotatif thermostat-trait blanc	01-11-13-	
3	025006		1		T-stat 0-90°C cap1500 bulb6 TU-L-DT	01-11-13-	Prev : 54442045 - Tableau électrique
4	54763009	785197	1		Thermomanomètre N-mini	01-11-13-	