













Components

		Code	Code GA	Quant.	Photo	Description	De --- A ---
1		788451	788451	1		Bouchon Ø1" laiton REF R 592 D Y 005	02-05-22-
2		54764037	785223	1		T-stat+reset 96°C 2pole (type TOD)	02-05-22-
3		54764015	785210	1		T-stat bimetal(open 60°, close 48°)	02-05-22-
4		788715	788715	1		Vis M4x6 DIN7985 StZn	02-05-22-
5		788714	788714	1		E-Tech M Peint corps	02-05-22-
6		788452	788452	1		Capteur NTC 10K D6,5X37 1/8 + molex conn.	02-05-22-
7		5476D004	786487	1		Resist.chauff. 2x3kW 230V E-Tech W36	02-05-22-
8		557A3007	786699	1		Purgeur air auto.composite P32 V14	02-05-22-
9		910392	910392	1		Purgeur manuel 1/2 "	02-05-22-
10		788730	788730	1		Autocollant panneau cōntrol E-Tech M version ACV	02-05-22-
11		788734	788734	1		Capot de protection pour plug XB5USB3	02-05-22-
12		788733	788733	1		Port USB A à monter sur panneau	02-05-22-
13		788731	788731	1		Écran TFT Color LCD 4.3" 480 x 272 pixels	02-05-22-
14		788732	788732	1		Head of turning button XB5 3pos Red	02-05-22-
15		557A0050	786580	1		Joint 30x20x2 fibre	02-05-22-
16		788478	788478	1		Collecteur hydraulique en laiton	02-05-22-
17		788712	788712	1		Joint d'étanchéité plat 3/8 (15x8x2mm)	02-05-22-
18		788713	788713	1		E-Tech M Flexible vase expansion	02-05-22-
19		788479	788479	1		Soupape sécurité 3BAR 52kW	02-05-22-
21		788480	788480	1		Tige soupape sécurité 3bar	02-05-22-



Components

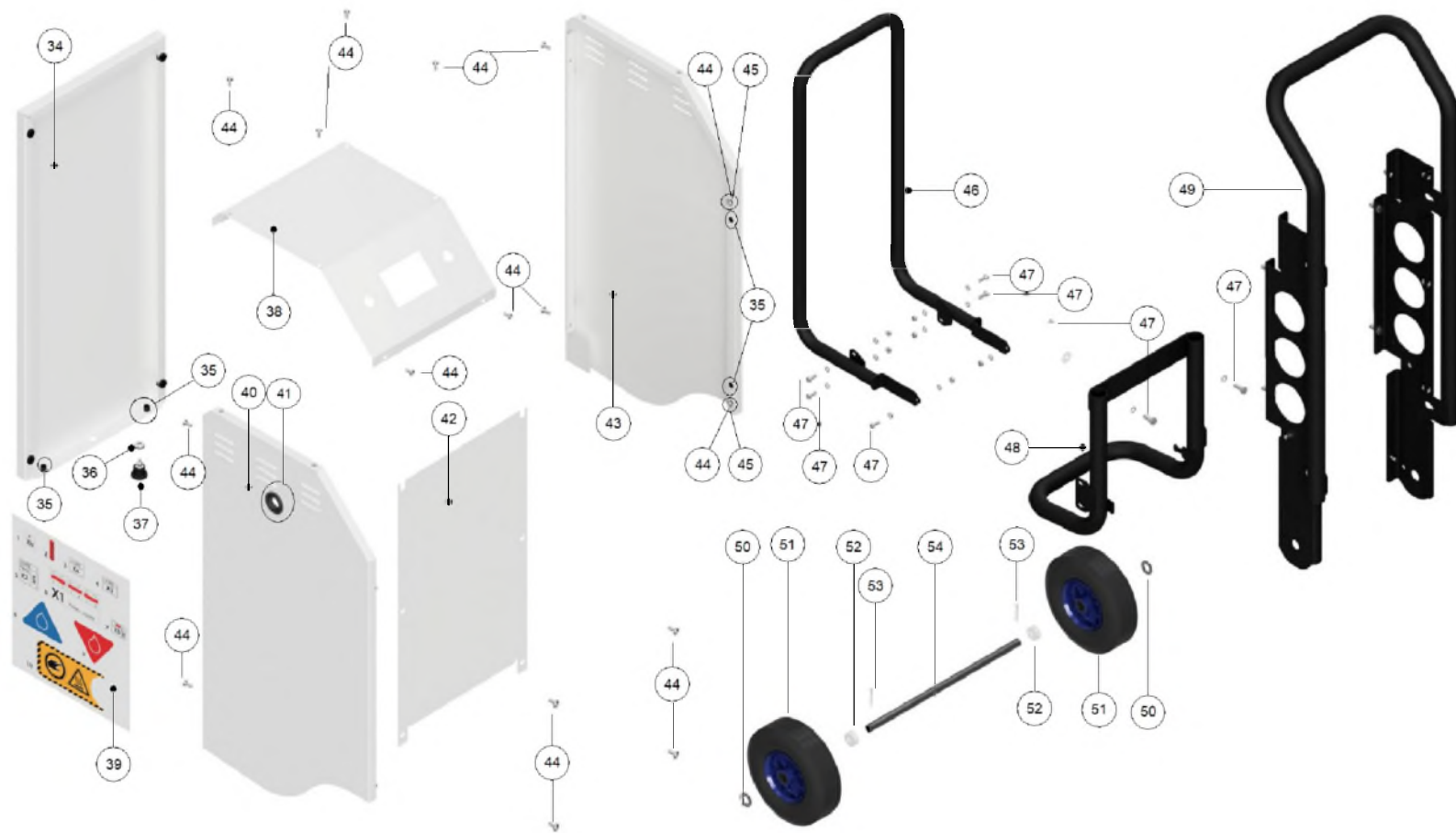

	Code	Code GA	Quant.	Photo	Description	De --- A ---
22	557A6010	786722	1		Capteur de pression Prest.V14	02-05-22-
23	507F4289	786034	1		Epingle capteur sonde Prest.V14	02-05-22-
24	788719	788719	1		Curved tube return/flow E-Tech M	02-05-22-
25	557A0051	786581	1		Joint 24x14x2 fibre	02-05-22-
26	788716	788716	1		Vanne à boisseau sphérique MF G3/4	02-05-22-
27	788720	788720	1		Raccord rapide laiton Geka F 3/4"	02-05-22-
28	788737	788737	1		Oeillet 60/41mm	02-05-22-
29	788736	788736	1		Plate galva protection pompe E-Tech M	02-05-22-
30	788738	788738	1		Écrou moleté 24x6mm DIN467 M6	02-05-22-
31	788726	788726	1		Vase expansion 12L G3/8	02-05-22-
32	780429	780429	1		Circulateur UPM3 15-75 L130 G1 EUX6	02-05-22-
33	788468	788468	1		Câble USB A Male <-> USB A Male (1m)	02-05-22-

Frame & Panels





Frame & Panels

	Code	Code GA	Quant.	Photo	Description	De --- A ---
34	030348	030348	1		E-Tech M Panneau anterieur (blanc)- ASSY	02-05-22-
35	788728	788728	1		Capuchon polyéthylène noir ø10/15 x 5mm	02-05-22-
36	788740	788740	1		Écrou M10 DIN439 STZN (low profile)	02-05-22-
37	788739	788739	1		Doigt d'indexage fileté M10	02-05-22-
38	788729	788729	1		E-Tech M Panneau superieur (blanc)	02-05-22-
39	788475	788475	1		Autocollants E-Tech M	02-05-22-
40	030346	030346	1		E-Tech M Panneau côté droite, avec trou pour purgeur (blanc) ASSY	02-05-22-
41	557A0060	786585	1		Joint soufflet d:21 Dp:40	02-05-22-
42	788735	788735	1		E-Tech M Panneau arrière (blanc)	02-05-22-
43	030347	030347	1		E-Tech M Panneau côté gauche (blanc) ASSY	02-05-22-
44	788476	788476	1		Vis M6x16 TX30 StZn 7380-2	02-05-22-
45	788727	788727	1		Entretoise diam6,1/8 x 4,2mm	02-05-22-
46	052825	052825	1		Barre protection optionelle avec fixation	02-05-22-
47	788477	788477	1		Vis M8x22 ISO4017 acier	02-05-22-
48	788717	788717	1		Tube structure (pied) E-Tech M	02-05-22-
49	030345	030345	1		E-Tech M Cadre avec barre de poignée -ASSY	02-05-22-
50	788724	788724	1		Rondelle plate 21x37x3 DIN443	02-05-22-
51	788723	788723	1		Pneu E-Tech M	02-05-22-
52	788722	788722	1		Entretoise PA diam35/21 x15mm	02-05-22-
53	788725	788725	1		Goupille fendue 4X36 ISO1234	02-05-22-



Frame & Panels

🗨	Code	Code GA	Quant.	Photo	Description	De --- A ---
54	788721	788721	1		E-Tech M Essieu de roue en inox	02-05-22-

Electric panel

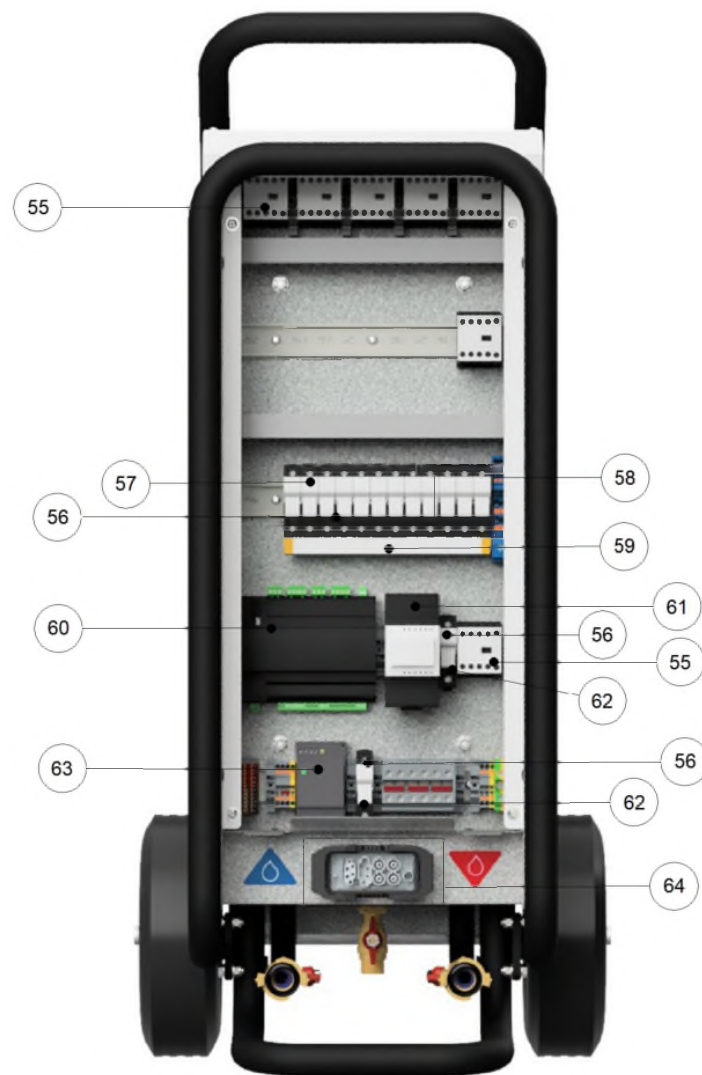



Electric panel

		Code	Code GA	Quant.	Photo	Description	De --- ▲ ---
		788454	788454	1		Vis M4x16	02-05-22-
		788463	788463	1		E-Tech M - Harnais de sécurité, PLC vers interrupteur ON/OFF et ToD	02-05-22-
		788464	788464	1		E-Tech M - Harnais capteur	02-05-22-
		788465	788465	1		E-Tech M - Harnais écran (alimentation + com)	02-05-22-
		788466	788466	1		Câble alimentation pompe	02-05-22-
		788467	788467	1		E-Tech M - Câble control pompe (pwm control)	02-05-22-
		788469	788469	1		Câble spécial 2,5 ² - 300mm (Blue) pour résistance	02-05-22-
		788470	788470	1		Câble spécial 2,5 ² - 300mm (Brown) pour résistance	02-05-22-
		788471	788471	1		Câble spécial 2,5 ² - 300mm (Black) pour résistance	02-05-22-
		788472	788472	1		Câble spécial 2,5 ² - 300mm (Gray) pour résistance	02-05-22-
		788473	788473	1		Câble spécial 2,5 ² - 500mm (Blue) pour résistance	02-05-22-
		788474	788474	1		Câble spécial 2,5 ² - 500mm (Brown) pour résistance	02-05-22-
		788718	788718	1		Câble spécial 2,5 ² - 150mm (Blue) pour résistance	02-05-22-
55		788458	788458	1		Contacteur 4NO 20A AC1 24Vdc	02-05-22-
56		A1003754		1		Interrupteur-fusible 1P-32A 10x38 mm	02-05-22-
57		788462	788462	1		Fusible 16A gG 10x38 mm	02-05-22-
58		788460	788460	1		Porte-fusible 3P 32A - taille fusible 10x38 mm - TeSys DF	02-05-22-
59		788459	788459	1		Busbar 100A 12P 3L 18mm	02-05-22-
60		788456	788456	1		Modicon M172 performance 28 E/S, Ethernet, Modbus	02-05-22-
61		788457	788457	1		Contacteur 3NO 80A AC1 24Vdc	02-05-22-



Electric panel

		Code	Code GA	Quant.	Photo	Description	De --- A ---
62		788461	788461	1		Fusible 2A gG 10x38 mm	02-05-22-
63		788455	788455	1		Alimentation Modicon Modular 24V 2,5A	02-05-22-
64		788453	788453	1		E-Tech M - Connecteur d'alimentation (assemblé)	02-05-22-