

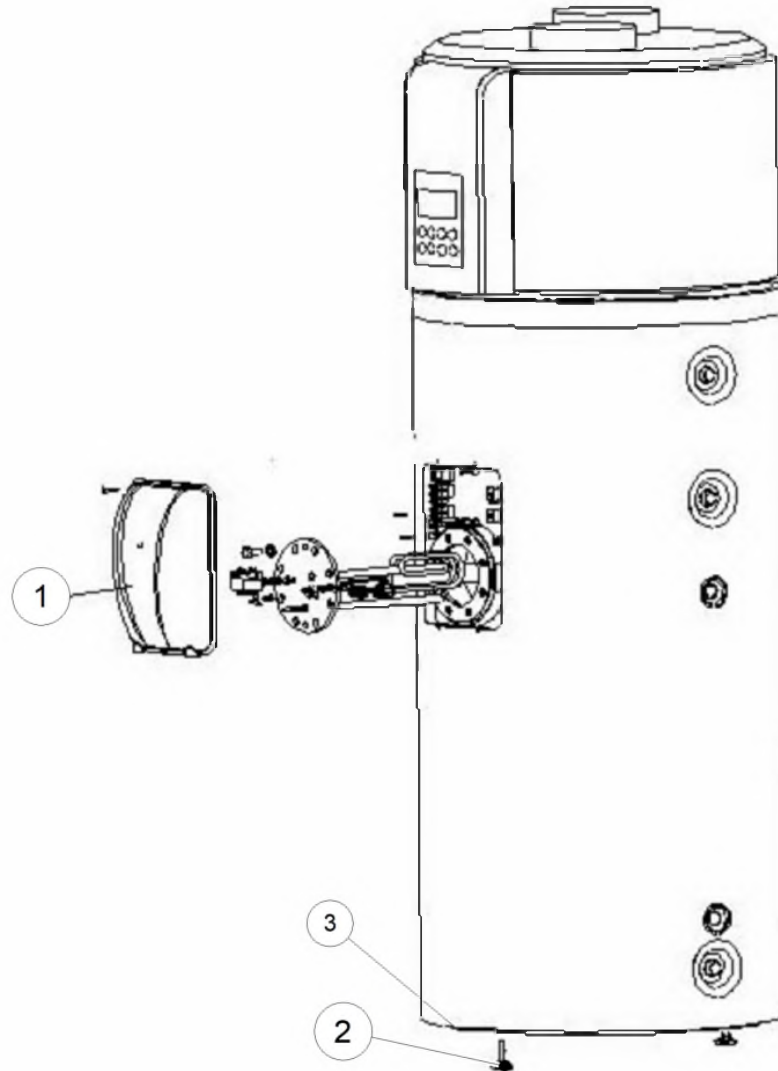

HP300 - HP300 C





External Glass HP300





External Glass HP300















	Code	Code GA	Quant.	Photo	Description
1	90000002	785307	1		Capot resist.chauff.HP300 noir
2	90000001	785306	3		Pied réglable HP300
3	A1004265	787313	1		Calotte inférieure HP 300

Compressor Glass HP300









Compressor Glass HP300

Code	Code GA	Quant.	Photo	Description	De --- A ---
1	90000014	785318	1	 Couvercle supérieur HP300	
2	90000015	785319	1	 Compresseur HP300	
3	90000005	785310	1	 Circuit impr.contr.HP300C	
4	90000007	785312	1	 Condensateur compr.HP300	
5	90000008		2	 Relais statique pour HP300	
6	90000009	785313	4	 Bloc connexion 2x4 faston HP300	
7	90000010	785314	1	 Condensateur mot. HP300	
8	90000006	785311	1	 Transformateur HP300	
10	90000004	785309	1	 Circuit impr.display HP300	
11	90000003	785308	1	Couvercle avant HP300 noir	
12	90000017	785321	1	 électrovanne HP300	
13	90000018	785322	1	 Vanne 4 voies HP300	
14	90000016	785320	1	 Pressostat entrée HP300	
15	90000019	785323	1	Vanne électronique d'expansion HP300	
16	90000020	785324	1	Pressostat sortie HP300	
17	90000021	785325	1	Sonde (T5Up) HP300	
18	90000022	785326	1	 Sonde (T5L) HP300	
19	90000023	785327	1	 Sonde (Th) HP300	
20	90000024	785328	1	Sonde (T3) HP300	
21	90000025	785329	1	 Sonde d'ambiance HP300 (T4)	



Compressor Glass HP300





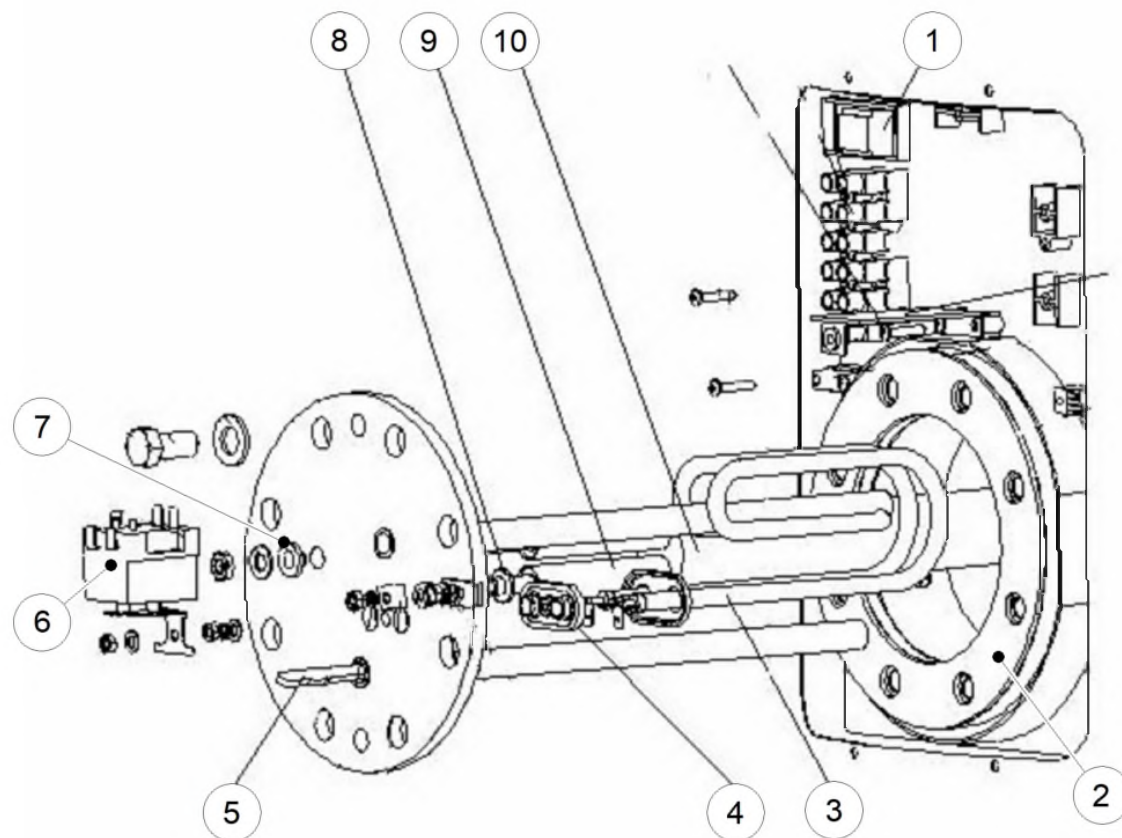

		Code	Code GA	Quant.	Photo	Description	De --- A ---
22		90000026	785330	1		Sonde décontamin. HP300 (Tp)	
23		90000011	785315	1		Moteur ventil. HP300	
24		90000012	785316	1		Roue ventil. HP300	
25		90000013	785317	1		Couvercle Arrière HP300	
26		90000047	785345	2		Collerette pour tube d'air DN190 HP300	
27		A1002123	786846	1		Cache display HP300 (sans circ.impr)	01-07-15-

Elec. heater Glass HP300





Elec. heater Glass HP300

Code	Code GA	Quant.	Photo	Description	De --- A ---	Remarque
1	90000036	785338	1	 Circuit impr.monitoring anode HP300		
2	90000027	785331	1	 Joint bride avant HP300		
3	90000028	785332	1	 Resist.chauff.1800W HP300 + joint		
4	90052041	785377	1	 Joint resist.chauff.BL Glass	01-12-17-	same as 90000029
5	90000035	785337	1	Lamelle sonde HP300 L=105		
6	90000030	785333	1	 T-stat cut-off 110°C HP300		
7	90000034	785336	2	 Rondelle isolante épaulée HP300 Polyam.		
8	90000033	785335	2	 Joint anode HP300 , à livrer avec anode		
9	90000032		1	 Gaine silicone anode HP300		
10	90000031	785334	1	 Anode HP300 avec 2 joints et gaines		