

Glass ST-Tri (wall)

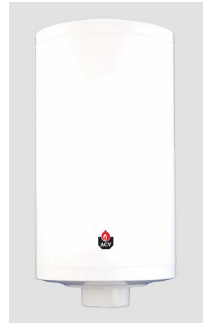

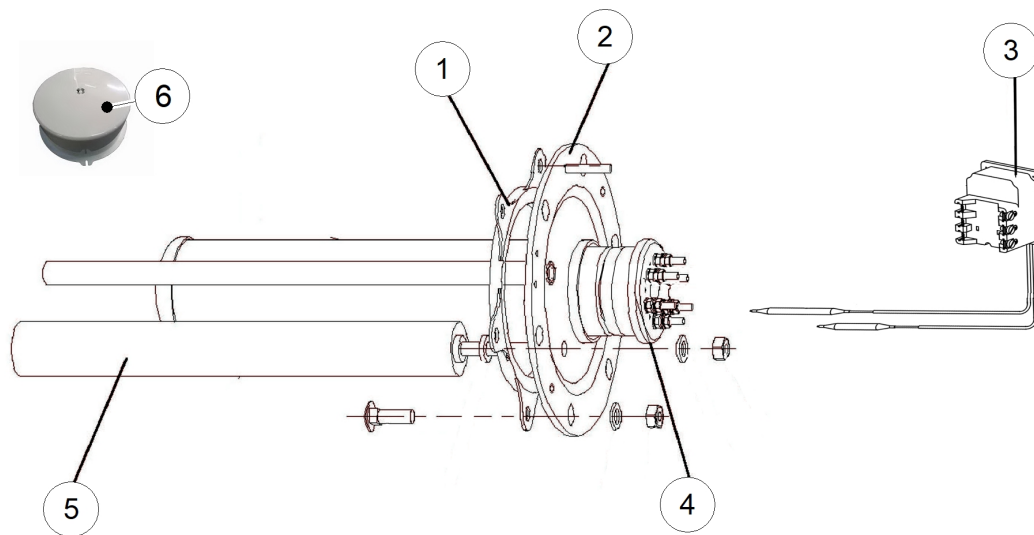

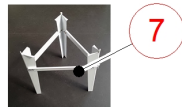





ST 150Tri - 200Tri





Glass ST-Tri (wall)

	Code	Code GA	Quant.	Photo	Description	De --- A ---	Remarque
1	90027044	785360	1		Joint de bride emboutie Glass		
2	90002141	785346	1		Bride ST mural tri Glass 150-200		For 150-200 litres
3	90057626	785379	1		T-stat (tri) BTS5005 Glass		
4	90047727	785376	1		Resist.chauff.ST 2400W tri		
5	90021033	785358	1		Anode (32x270)+joint Glass150-200-300		
6	90014032	785350	1		Capot BL-ST vertical blanc Glass		
7	507F4262		0		Trépied Glass OBSOLETE	-01-03-18	OBSOLETE
	A1006353	780152	1		Barre de liaison étoile électrique (tri)	-07-08-20	