



Cadenso

40 - 100 kW







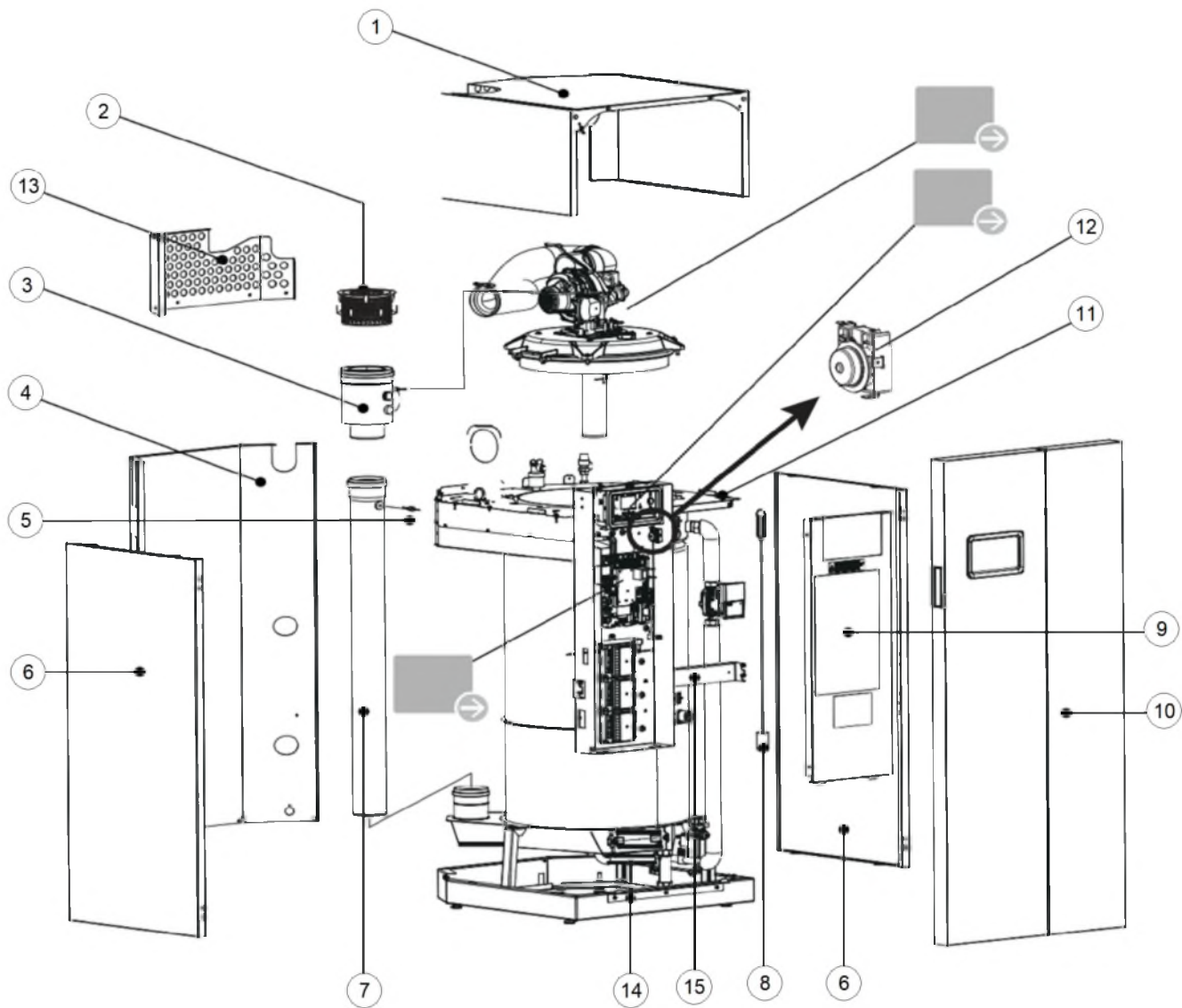







041871 CADENSO 40
041872 CADENSO 60
041873 CADENSO 70
041874 CADENSO 80
041875 CADENSO 100

Habillage - Isolation



Habillage - Isolation

	Code	Quant.	Photo	Description	De --- A ---	Remarque
0	072295	1		Tube de graisse pour joint ventouse	01-01-21-	Tube de graisse pour joint ventouse
0	073722	1		Isolation corps- 40-60 kW	01-01-21-	Isolation corps- 40-60 kW
0	076917	1		Isolation corps- 70-80-100 kW	01-01-21-	Isolation corps- 70-80-100 kW
0	078657	1		Rallonge sonde fumée	01-01-21-	Rallonge sonde fumée
0	078660	1		Adaptateur C53	01-01-21-	Adaptateur C53
1	079245	1		Capot superieur - 40-60 kW	01-01-21-	Capot superieur - 40-60 kW
1	079246	1		Capot superieur - 70-80-100 kW	01-01-21-	Capot superieur - 70-80-100 kW
2	073417	1		Filtre à air	01-01-21-	Filtre ... air
3	071918	1		Adaptation concentrique- 40-60 kW	01-01-21-	Adaptation concentrique- 40-60 kW
3	072575	1		Adaptation concentrique - 70-80-100 kW	01-01-21-	Adaptation concentrique - 70-80-100 kW
4	071929	1		Jaquette arrière- 40-60 kW	01-01-21-	Jaquette arrière- 40-60 kW
4	072583	1		Jaquette arrière- 70-80-100 kW	01-01-21-	Jaquette arrière- 70-80-100 kW
5	071908	1		Sonde fumées avec joint	01-01-21-	Sonde fumées avec joint
6	079247	1		Jaquette latérale- 40-60 kW	01-01-21-	Jaquette lat,rale- 40-60 kW
6	079248	1		Jaquette latérale- 70-80-100 kW	01-01-21-	Jaquette lat,rale- 70-80-100 kW
7	071919	1		Conduit fumées avec joints- 40-60 kW	01-01-21-	Conduit fumées avec joints- 40-60 kW
7	072576	1		Conduit fumées avec joints- 70-80-100 kW	01-01-21-	Conduit fumées avec joints- 70-80-100 kW
8	072226	1		Goupillon	01-01-21-	Goupillon
9	078659	1		Tole de fermeture du tableau de commande	01-01-21-	Tole de fermeture du tableau de commande
10	079249	1		Jaquette avant- 40-60 kW	01-01-21-	Jaquette avant- 40-60 kW



Habillage - Isolation

	Code	Quant.	Photo	Description	De --- A ---	Remarque
10	079250	1		Jaquette avant- 70-80-100 kW	01-01-21-	Jaquette avant- 70-80-100 kW
11	078641	1		Jaquette supérieure- 40-60 kW	01-01-21-	Jaquette sup,rieure- 40-60 kW
11	078642	1		Jaquette supérieure- 70-80-100 kW	01-01-21-	Jaquette sup,rieure- 70-80-100 kW
12	000267	1		Thermostat de sécurité	01-01-21-	Thermostat de s,curit,
13	078643	1		Grille arrière- 40-60 kW	01-01-21-	Grille arriŠre- 40-60 kW
13	078644	1		Grille arrière- 70-80-100 kW	01-01-21-	Grille arriŠre- 70-80-100 kW
14	078648	1		Cornière support jaquette avant	01-01-21-	CorniŠre support jaquette avant
15	078645	1		Traverse avant- 40-60 kW	01-01-21-	Traverse avant- 40-60 kW
15	078646	1		Traverse avant- 70-80-100 kW	01-01-21-	Traverse avant- 70-80-100 kW

Tableau de commande



Tableau de commande







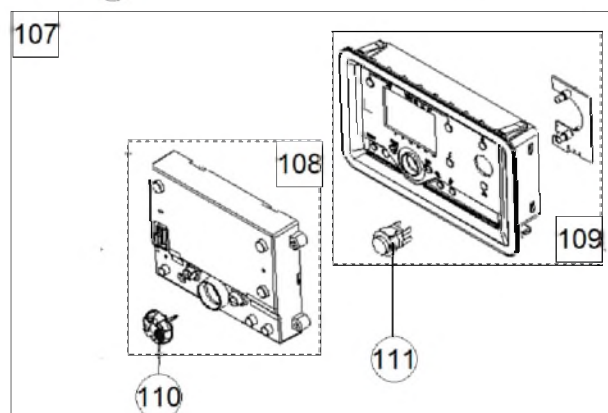
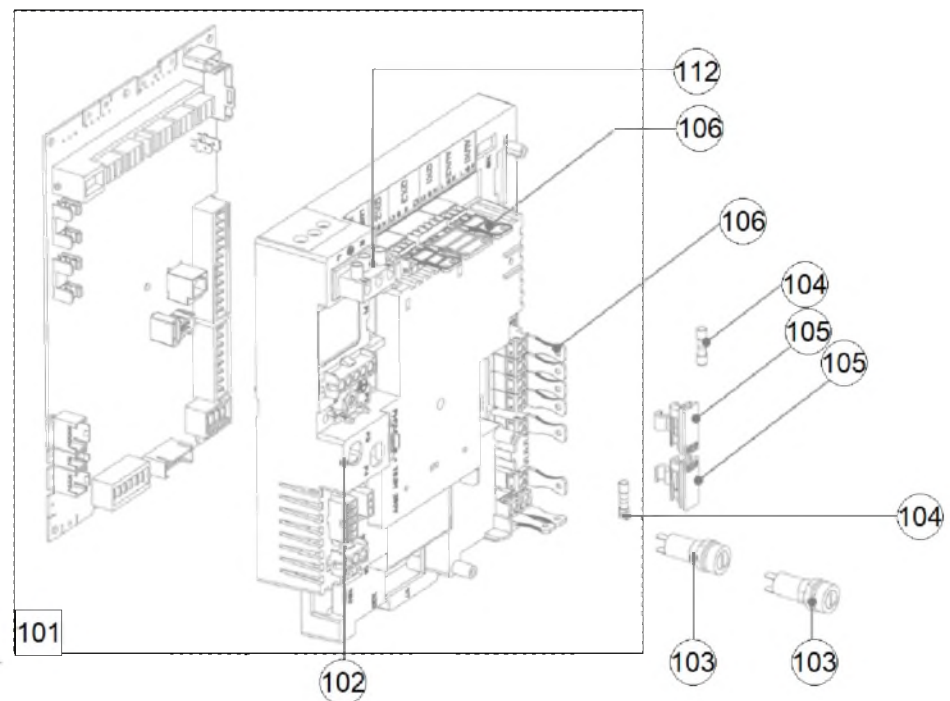

















		Code	Quant.	Photo	Description	De --- A ---	Remarque
0		076146	1		Filerie alimentation AVS75	01-01-21-	
0		076147	1		Nappe de commande AVS75	01-01-21-	
0		076148	1		Nappe afficheur	01-01-21-	
0		076386	1		Filerie alimentation signal circulateur / contrôleur de débit	01-01-21-	
0		076387	1		Filerie signal ventilateur / sonde / capteur	01-01-21-	
0		076388	1		Filerie interne sonde fumée	01-01-21-	
0		076390	1		Filerie alimentation regroupée vanne / ventilateur/ ionisation	01-01-21-	
0		078653	1		Filerie alimentation brûleur	01-01-21-	
0		078654	1		Filerie commande brûleur	01-01-21-	
0		078655	1		Filerie alimentation interrupteur	01-01-21-	
0		078656	1		Filerie de terre	01-01-21-	
0		078658	1		Fond de tableau de commande préparé	01-01-21-	
101		078814	1		Plate-forme avec Siemens LMS paramétré	01-01-21-	40 kW
101		078816	1		Plate-forme avec Siemens LMS paramétré	01-01-21-	60 kW
101		078817	1		Plate-forme avec Siemens LMS paramétré	01-01-21-	70 kW
101		078818	1		Plate-forme avec Siemens LMS paramétré	01-01-21-	80 kW
101		078819	1		Plate-forme avec Siemens LMS paramétré	01-01-21-	100 kW
102		076127	1		Plate-forme sans Siemens LMS et avec filerie	01-01-21-	
103		076130	1		Porte fusible rond	01-01-21-	
104		071898	1		Fusible (T 6,3 H - 5x20)	01-01-21-	

Tableau de commande

🗨	Code	Quant.	Photo	Description	De --- A ---	Remarque
105	076129	1		Porte fusible carré (avec fusible)	01-01-21-	
106	076128	1		Connecteurs client plate-forme	01-01-21-	
107	078782	1		Afficheur complet (HMI)	01-01-21-	
108	078477	1		Afficheur seul (HMI) avec sa molette de sélection	01-01-21-	
109	078704	1		pièce plastique afficheur (HMI) + carte LED + interrupteur + nappe LED	01-01-21-	
110	076135	1		Molette de sélection	01-01-21-	
111	076134	1		Interrupteur	01-01-21-	
112	076523	1		Connecteur alimentation électrique	01-01-21-	

Corps



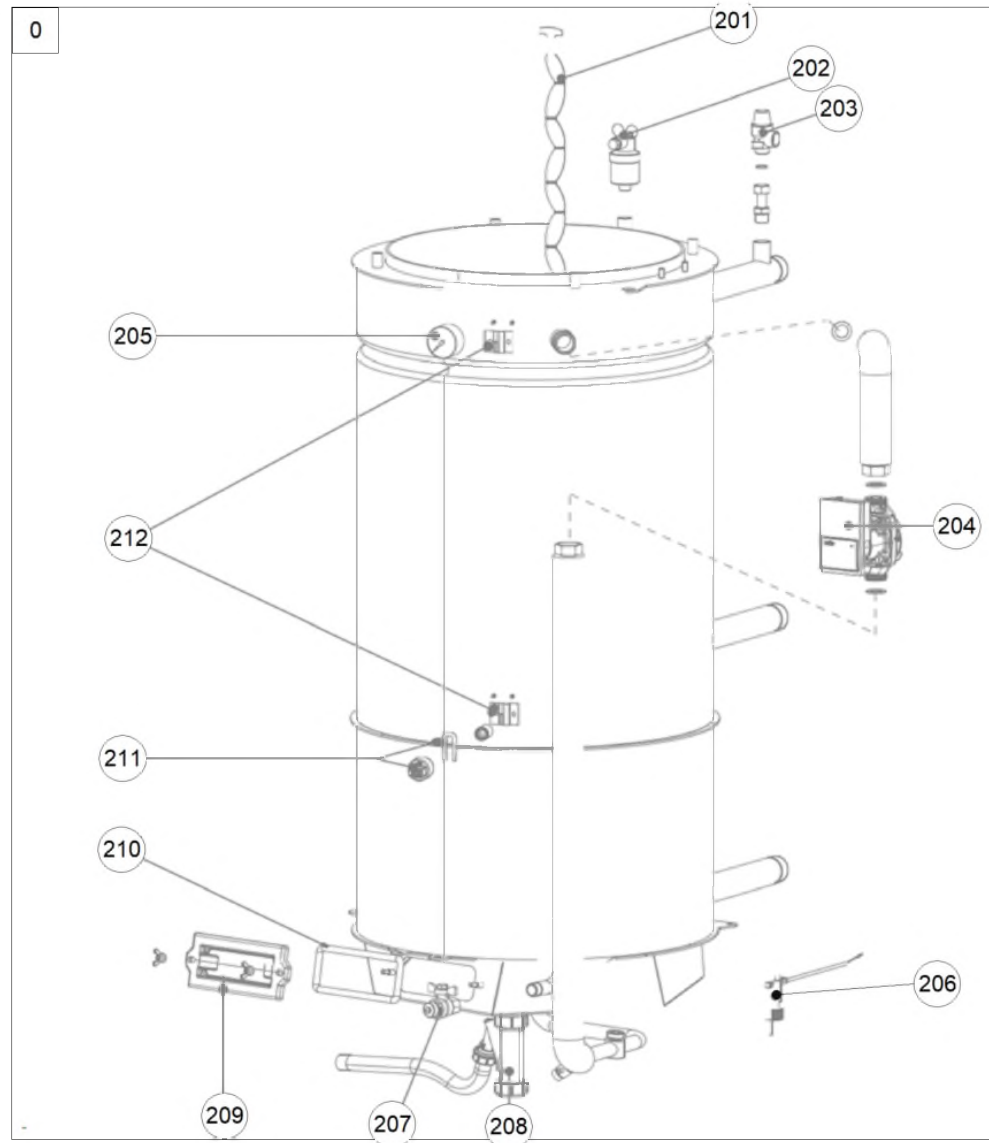







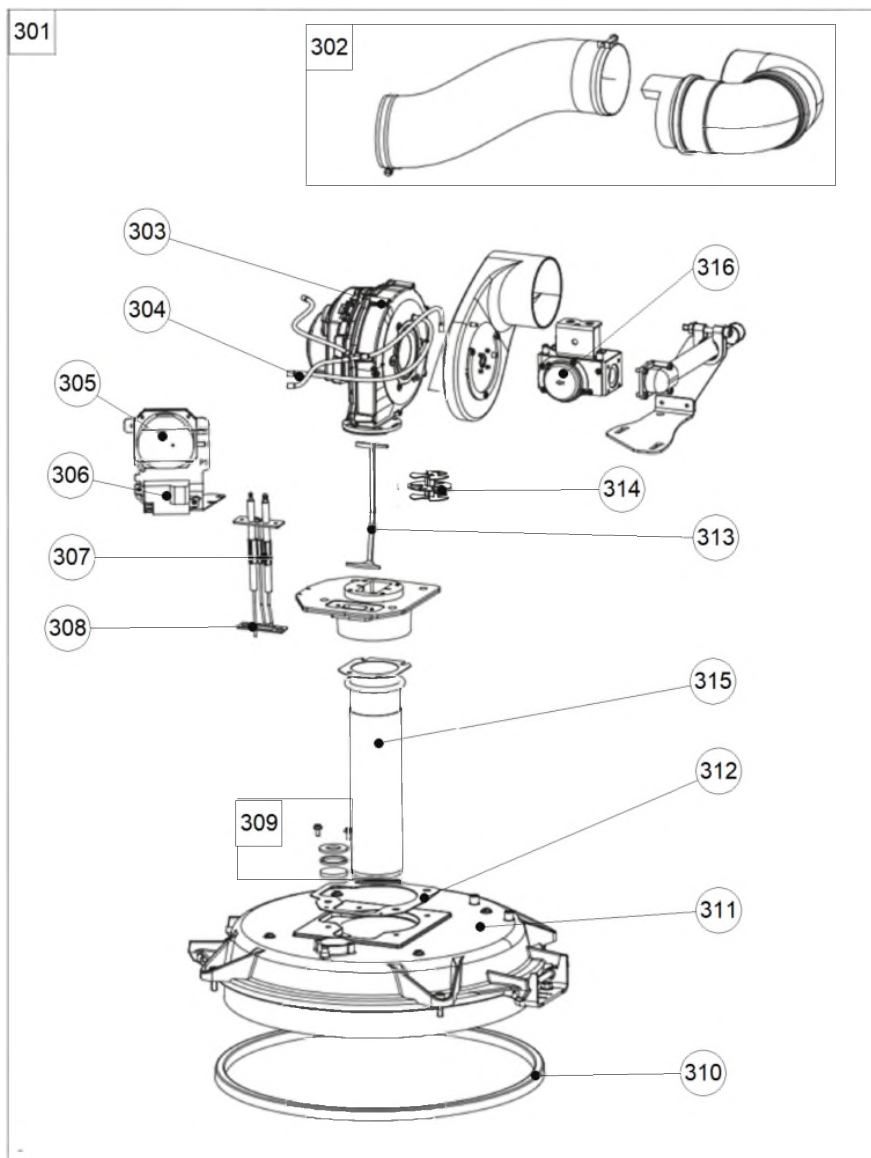













Corps

	Code	Quant.	Photo	Description	De --- A ---	Remarque
0	078649	1		Corps complet40 kW	01-01-21-	40 kW
0	078650	1		Corps complet60 kW	01-01-21-	60 kW
0	078651	1		Corps complet70 kW & 80 kW	01-01-21-	70 kW & 80 kW
0	078652	1		Corps complet100 kW	01-01-21-	100 kW
201	071920	1		Turbulateurs (jeu complet)60 kW	01-01-21-	60 kW
201	072356	1		Turbulateurs (jeu complet)40 kW	01-01-21-	40 kW
201	072578	1		Turbulateurs (jeu complet)70 kW & 80 kW	01-01-21-	70 kW & 80 kW
201	072579	1		Turbulateurs (jeu complet)100 kW	01-01-21-	100 kW
202	071924	1		Purgeur	01-01-21-	
203	072165	1		Soupape	01-01-21-	
204	076391	1		Pompe irrigation	01-01-21-	
205	078647	1		Manomètre	01-01-21-	
206	072591	1		Contrôleur de débit	01-01-21-	
207	072577	1		Robinet de vidange	01-01-21-	
208	071925	1		Siphon évacuation condensats	01-01-21-	
209	076230	1		Trappe de visite boîte ? fumées	01-01-21-	
210	071921	1		Joint trappe de visite boîte ? fumées	01-01-21-	
211	073946	1		Capteur de pression avec pièce de maintien	01-01-21-	
212	071899	1		Sonde départ / retour	01-01-21-	

Brûleur





Brûleur

	Code	Quant.	Photo	Description	De --- A ---	Remarque
0	072251	1		Câble électrode brûleur d'allumage	01-01-21-	
0	072775	1		Câble alimentation vanne gaz	01-01-21-	
301	072375	1		brûleur + porte40 kW	01-01-21-	40 kW
301	076377	1		brûleur + porte60 kW	01-01-21-	60 kW
301	076378	1		brûleur + porte70 kW & 80 kW	01-01-21-	70 kW & 80 kW
301	076379	1		brûleur + porte100 kW	01-01-21-	100 kW
302	071913	1		Flexible air40kW & 60 kW	01-01-21-	40kW & 60 kW
302	072571	1		Flexible air70-80-100 kW	01-01-21-	70-80-100 kW
303	071917	1		Ventilateur40kW	01-01-21-	40kW
303	076380	1		Ventilateur60Kw	01-01-21-	60Kw
303	076381	1		Ventilateur70-80-100 kW	01-01-21-	70-80-100 kW
304	072596	1		Tuyau versilic (avec tétine de jonction)40kW & 60 kW	01-01-21-	40kW & 60 kW
304	072597	1		Tuyau versilic (avec tétine de jonction)70-80-100 kW	01-01-21-	70-80-100 kW
305	071915	1		Pressostat air40kW & 60 kW	01-01-21-	40kW & 60 kW
305	072573	1		Pressostat air70-80-100 kW	01-01-21-	70-80-100 kW
306	072131	1		Transformateur d'allumage	01-01-21-	
307	072005	1		Bloc électrodes	01-01-21-	
308	073890	1		Joints bloc électrode (x 3)	01-01-21-	
309	060407	1		Verre pyrex + 2 joints	01-01-21-	
311	071910	1		Porte foyère complète40kW & 60 kW	01-01-21-	40kW & 60 kW



Brûleur

	Code	Quant.	Photo	Description	De --- A ---	Remarque
311	072569	1		Porte foyère compl?te70-80-100 kW	01-01-21-	70-80-100 kW
312	071914	1		Joints brûleur40kW & 60 kW	01-01-21-	40kW & 60 kW
312	072572	1		Joints brûleur70-80-100 kW	01-01-21-	70-80-100 kW
313	073186	1		D?électeur70-80-100 kW	01-01-21-	70-80-100 kW
314	072355	1		Déphaseur40kW	01-01-21-	40kW
314	073121	1		Déphaseur60kW	01-01-21-	60kW
315	071916	1		Rampe gaz40kW & 60 kW	01-01-21-	40kW & 60 kW
315	072574	1		Rampe gaz70-80-100 kW	01-01-21-	70-80-100 kW
316	071912	1		Vanne gaz40kW & 60 kW	01-01-21-	40kW & 60 kW
316	072570	1		Vanne gaz70-80-100 kW	01-01-21-	70-80-100 kW