

Smart ME 200

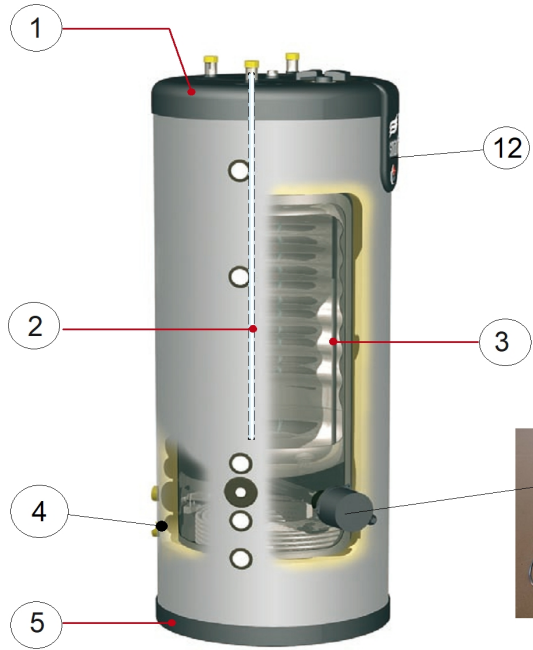
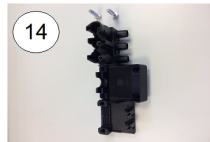

6

7A

8A

9

10















10A

11

25



Smart ME 200

Code	Code GA	Quant.	Photo	Description	De --- A ---	Remarque
1	497B5010	785900	1	 Calotte supérieure Smart STD 100-240		
2	497B0051	785865	1	 Plonge PVCc 19,5x840 perç.lat.		Prev: 497B0005
3	39438039	784823	1	 Doigt de gant inox 1/2x750		
4	63438001	785296	1	 Doigt de gant laiton 1/2x100 3 bulbes		
5	A1003197	787146	1		Calotte inférieure Smart 100 -> 240 V08	01-11-16- PREV 497B5015
6	55445006	785282	1	 Purgeur air man.1/2		
7A	A1002122	786845	1	 Support câblé Smart E, 600 hard_j V15	01-01-16-	prev 24614152
8A	A1002038	786807	1	 T-stat 0-80°C cap1500 bulb6 TU-L-DT	01-01-16-	prev 54442045
9	54764021	785212	1	 Bouton rotatif thermostat-trait blanc		
10	A1002100	786836	1	 T-stat+reset 86°C cap900 bulb6 TS-RM-DT	-30-05-18	Prev : 54764020
10A	A1002099	786835	1		T-stat 0-80° cap1500 bulb6 TU-45-DTvis	01-01-16-
11	54763020	785204	1	 Thermomètre 0-120°C Dp:52 SmartLine	01-07-12-	
12	497B4001	788147	1	 Support logo SMART Line 100-240-320		
13	54428130	785145	1	 Prise M. 3 pôles		
14	54428131	785146	1	 Prise F. 3 pôles		
25	54764032	785220	0	 T-stat 0-85°C+110°C safety 3ph.	01-11-12-	for 10800081-4 heating elements
90	60772083	788134	1		boîte Smart 210	
90	60772086	200029	1		Fond Emballage Smart standard	