

Panels HM201 V17

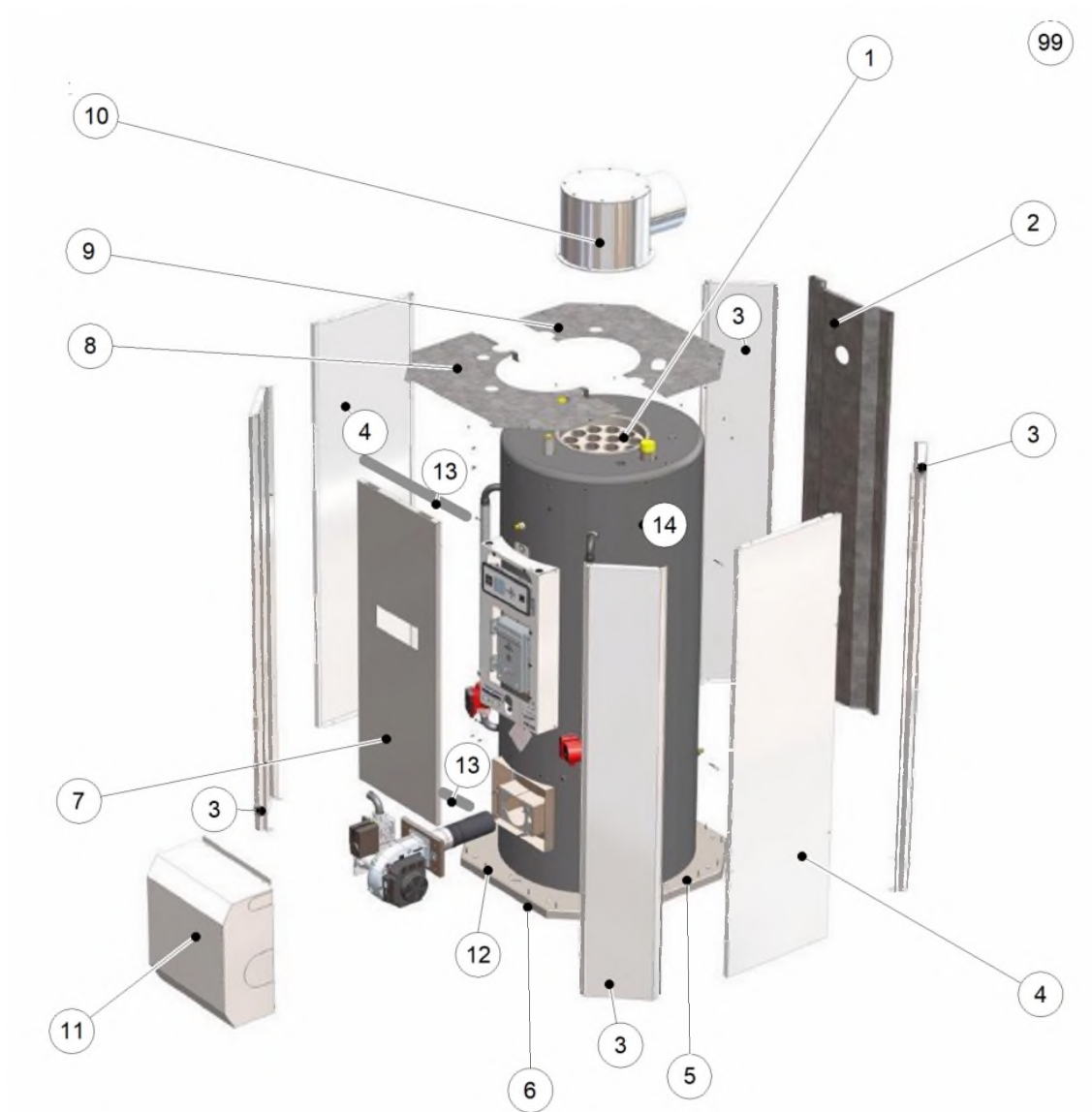



Panels HM201 V17





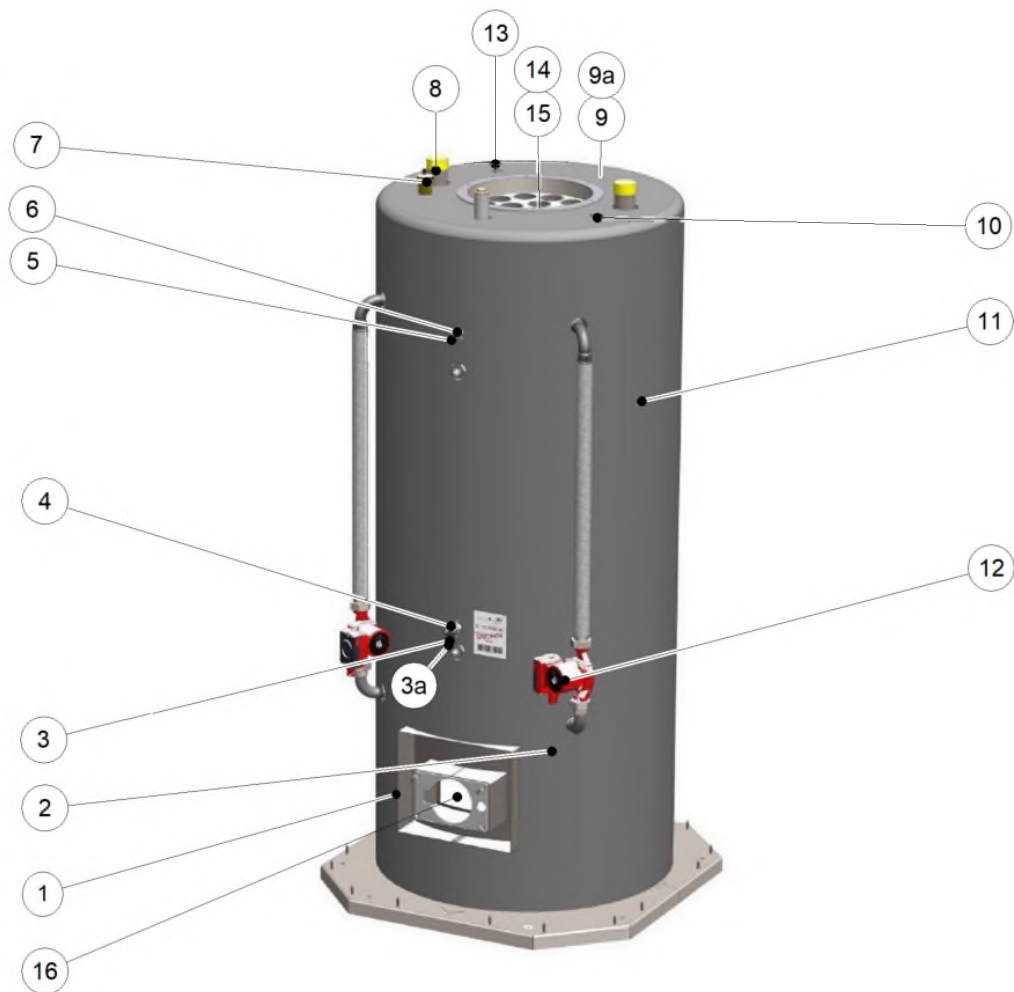







☒	Code	Code GA	Quant.	Description	From --- To ----
1	A1004985		1	Body HM201 V17 painted	01-04-18-
2	A1004868		1	Rear panel assy HM201 V17	01-04-18-
3	A1004869		4	Corner panel assy HM201 V17	01-04-18-
4	A1004856		2	Side Panel L/R HM201 V17	01-04-18-
5	A1004854		1	Base panel rear HM201 V17	01-04-18-
6	A1004853		1	Base panel front HM201 V17	01-04-18-
7	A1004870		1	Front panel assy HM201 V17	01-04-18-
8	A1004859		1	Top panel front HM201 V17	01-04-18-
9	A1004860		1	Top panel rear HM201 V17	01-04-18-
10	507F3044	785942	1	Flue hood horiz.HM200-201	01-04-18-
11	A1004827		1	Burner cover assy HM201 V17	01-04-18-
12	47405045		16	Spring pin 8x30 DIN1481	01-04-18-
13	A1004872		2	Spacing profile HM201 V17	01-04-18-
14	A1004883		1	Kit Soft insulation HM201 V17	01-04-18-
99	A1005171		1	Kit screws for casing HM201 V17	01-04-18-

Internal HM201 V17





Internal HM201 V17



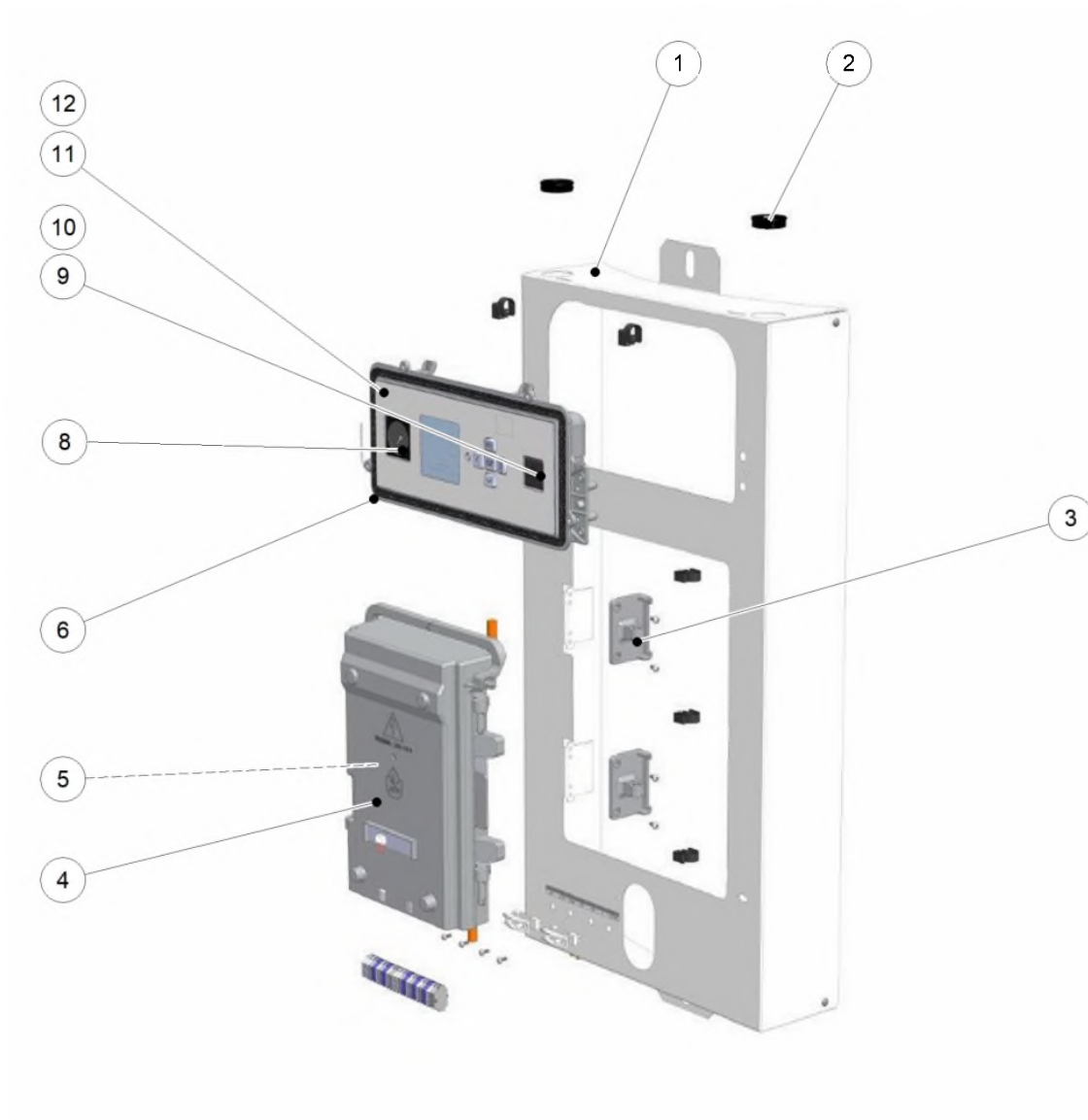

Code	Code GA	Quant.	Picture	Description	From --- To ----	Remark
1	A1004985	1		Body HM201 V17 painted	01-04-18-	
2	5476g054	786524	2	 NTC sensor 12K d5x50 1/8 +Molex conn.	01-04-18-	
3	507F4288	786033	1	Adapter pressure sensor P100-120 V14	01-04-18-	
3a	507F4289	786034	1	 Pin pressure sensor Prest.V14	01-04-18-	
4	557A6010	786722	1	 Pressure sensor Prest.V14	01-04-18-	
5	557A5005	786717	1	 Check valve for Manometer 1/4	01-04-18-	
6	43416065	784848	1	Reducer MF 1/2 x 1/4 brass	01-04-18-	
7	557A3001	786695	1	 Air vent auto.1/2 brass	01-04-18-	
8	497B0502	785869	1	Sparge tube PVCc 50x1300 unplug.	01-04-18-	
9	39438030	784822	1	 Dry well SST 1/2x1300	01-04-18-	
9a	5476G003	786491	1	 NTC sensor 12k L:3200mm for tank	01-04-18-	
10	5476g054	786524	1	 NTC sensor 12K d5x50 1/8 +Molex conn.	01-04-18-	
11	A1004883		1	Kit Soft insulation HM201 V17	01-04-18-	
12	A1006377	780157	2	Assembly UPML 25-105 L180 G1.5&Connector	29-10-19-	Prev : A1002169
13	55445006	785282	1	 Air vent man.1/2	01-04-18-	
14	507F2009	785930	15	 Turbulator upper HM type A	01-04-18-	
15	507F2010	785931	45	 Turbulator lower HM type B	01-04-18-	
16	51700094	784990	2	 Insul.sheet (1/2 disk) D680x13 HM201	01-04-18-	

Control Panel HM201 V17





Control Panel HM201 V17





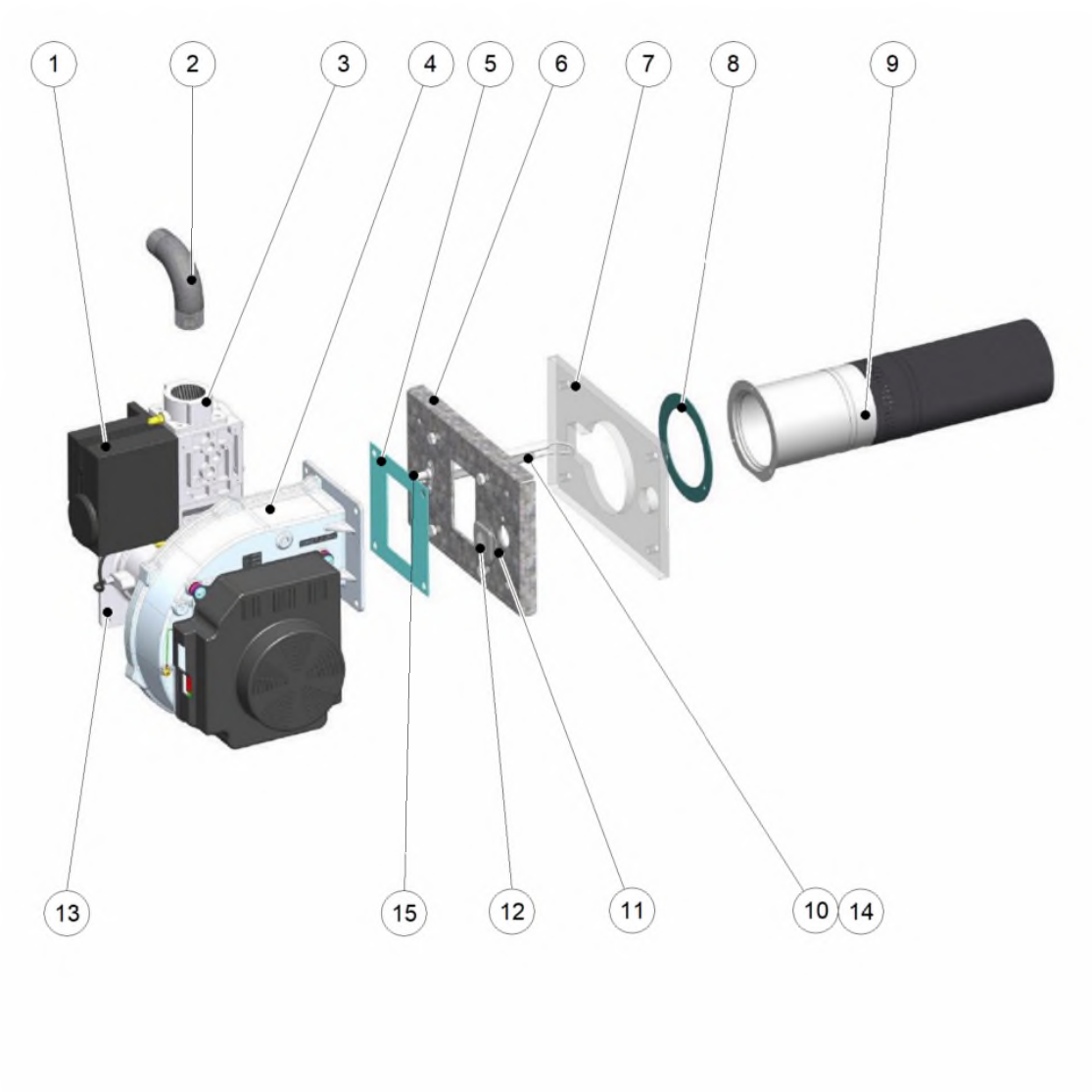





Code	Code GA	Quant.	Picture	Description	From --- To ----	
1	A1004861	787404	1		Panel for display HM201 V17	01-04-18-
2	5476A006	786474	2		Grommet splitted Ø29.8	01-04-18-
3	5476V056	786553	2		Hinge control box Prest.V14	01-04-18-
4	A1004992		1		Control box assy HM201 V17 SW041	01-04-18-
5	A1003599	787222	1		Printed circ.ACVMAX 230V (E) S4962S3038B	01-04-18-
6	A1004991	787409	1		Display box assy HM Prest Ver.F SW 3.16	01-04-18-
8	A1002841	787025	1		Manometer 0-4bar-60psi D:37 square flex	01-04-18-
9	54764038	785224	1		Switch 2P 16A/250VAC ACV MAX V14	01-04-18-
10	54766030	785241	1		Cover for I/O switch Prest.V14	01-04-18-
11	5476V053	786552	1		Front cover display box ACVMAX no sticker	01-04-18-
12	617G0452	786781	1		Sticker display box ACVMAX	01-04-18-

Burner HM201 V17





Burner HM201 V17

		Code	Code GA	Quant.	Picture	Description	From --- To ----
1		A1004282	787315	1		Gas valve VR425VE5022-0000	01-04-18-
2		42416212	784841	1		Curve 90° MM 4/4 fig.3	01-04-18-
3		A1004290	787317	1		Kit gasket flange Combi-Valve DN25	01-04-18-
4		537D3034	786097	1		Fan for HM201	01-04-18-
5		557A0040	786578	1		Gasket fan to door HM201	01-04-18-
6		A1004227	787312	1		Burner Plate HM201V17	01-04-18-
7		A1004274	787314	1		Burner insul. 2in1 HM201 V17	01-04-18-
8		557A0020	786567	1		Gasket burner head BG2000S- 100 HM101- 201	01-04-18-
9		537DZ019	786448	1		Burner head NIT 98x372	01-04-18-
10		537DZ045	786465	1		électrode 185-15-RH dbl.ceram	01-04-18-
11		557A0155	786629	1		Gasket kerlane Ø44x28x2	01-04-18-
12		50423365	784922	1		Sight glass Furigas (assembly)	01-04-18-
13		A1004285	787316	1		Venturi VMU300A1004	01-04-18-
14		557A0163	786635	1		Gasket électrode dual ceramic	01-04-18-
15		A1002668	787016	1		Ignition cable HeatMAster Large	24-09-18-