

BMV 1-2 (->2012)

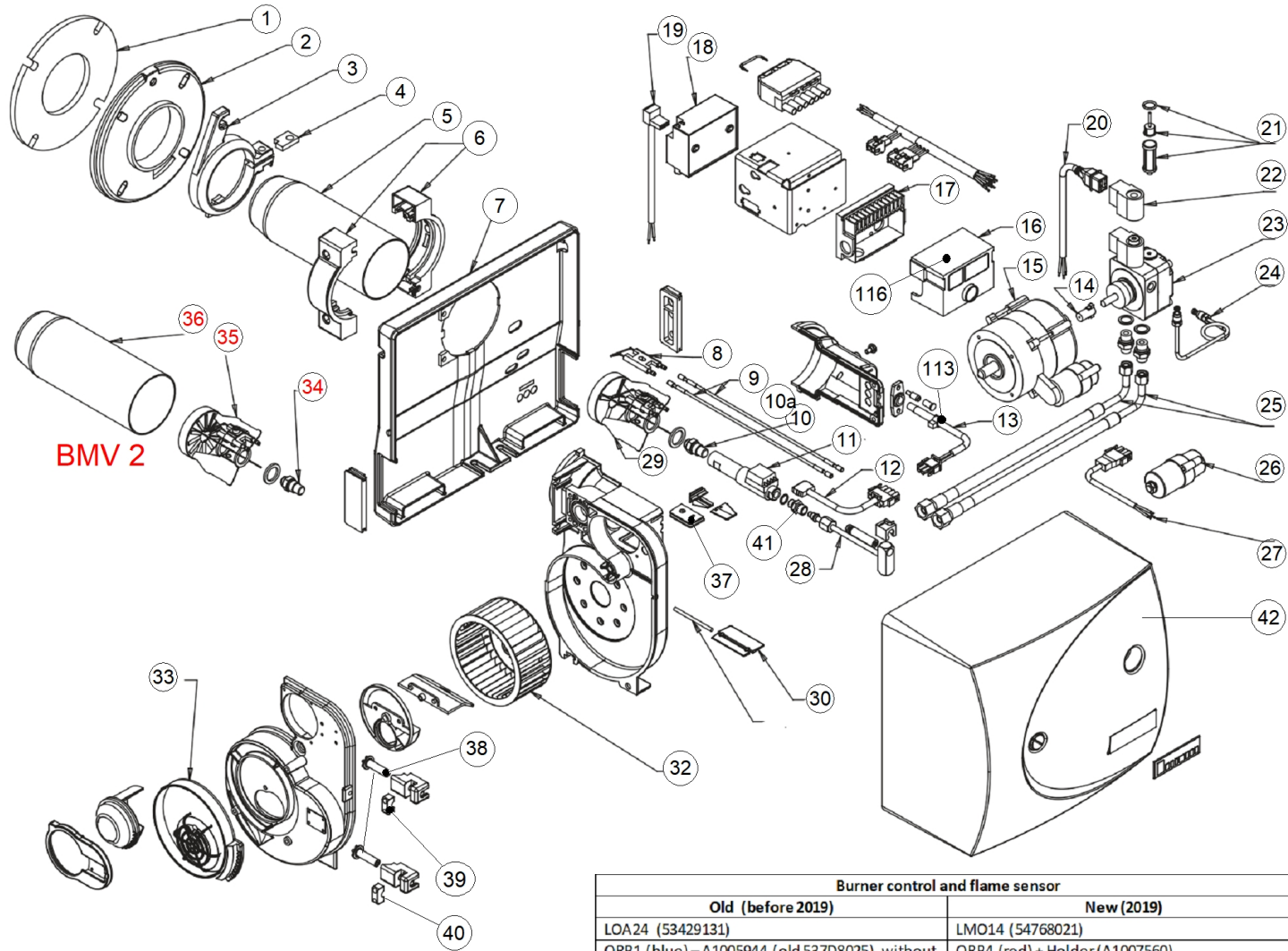













Burner control and flame sensor	
Old (before 2019)	New (2019)
LOA24 (53429131)	LMO14 (54768021)
QRB1 (blue) – A1005944 (old 537D8025) without holder	QRB4 (red) + Holder (A1007560)
QRB4 (red) <b>not compatible</b> with LOA	QRB1 <b>compatible</b> Older version compatible (with specific holder)



## BMV 1-2 (-&gt;2012)



Code	Code GA	Quant.	Photo	Description	De --- A ---	Remarque
1	55429159	785279	1	Joint bride ronde BMV & BMR22-32-52		not 557A0091
2	537D8147	786403	1	Plaque de collerette BMV		
3	537D8143	786400	1	Clame fix.brûleur BMV ->2012	-31-12-12	After 2012: A1002667
4	537D8144	786401	1	Joint d'étanchéité collerette BMV		
5	537D8096	786388	1	Tube de combustion BMV1 (E)		
6	537D8150	786405	1	Flasque bipartie BMV		
7	537D8140		0	OBS Plaque de base BMV1-2 ->2012 (-08)	-31-12-12	OBSOLETE
8	537DZ024	786450	1	Bloc d'électrodes BMV		
9	537D5014	786176	2	Câble allumage BMV		
10a	537D1026	786075	1	Gicleur Danfoss 0.75 Gus 60°H		
10	537D1028	786077	1	Gicleur Danfoss 0.60 Gus 45°H		Default, for Delta Pro
11	53429132	785065	1	Préchauffeur (seul) FPHB 5 (->FPHE 5)		Prev: 537D8034
12	537D5012	786174	1	Câble et prise mâle du prechauffeur		
13	A1005944	910421	1	Cellule BMV1-5 (10011.00105)	11-02-20-	Prev : 537D8025
14	537D8081	786381	1	Accouplement moteur-pompe BMV		
15	537D8031	786373	1	Moteur EB95C28 avec condensateur		
16	53429131	785064	1	Coffret de sécurité LOA 24 brûleur		
17	537D8035	786376	1	Socle enfichable BMV		
18	537D8036	786377	1	Transfo d'allumage BMV(U)	01-01-12-	prev: 537D8098
19	537D5013	786175	1	Câble transfo allumage		

## BMV 1-2 (-&gt;2012)

Code	Code GA	Quant.	Photo	Description	De --- A ---	Remarque
20	537D5010	786173	1	 Câble électro-aimant		
21	537D8024	786367	1	 Cartouche filtrante pour pompe		
22	A1005310	787441	1	Bobine électrovanne BMV T85	01-05-18-	prev: 537d8030
23	537D8033	786375	1	 Pompe BMV1 (Danfoss BFP21 L3 R) +bobine		not 53429048
24	537D8032	786374	1	 Conduite de pression de fioul		
25	537D8082	786382	1	 Flexible fioul 1100 mm		
26	537D8028	786371	1	 Condensateur (moteur BMV) 3µF		
27	537D5011		1	Câble de connexion du moteur		
28	537D1036	786083	1	 Tube porte-gicleur BMV1-2 (223,5mm)		
29	537D9000	786423	1	 Accroche flamme BMV1-3-4 (4 fentes)		
30	537D8084	786384	1	Clapet d'air BMV		
32	537D8026	786369	1	 Roue ventil.BMV		
	537D8029		1	-OBS-Entrée d'air avec grille de protection	-29-09-21	- Obsolete - HotSpot n°33
34	537D1027	786076	1	Gicleur Danfoss 1.25 Gus 60°H		
35	537D9001	786424	1	 Accroche flamme BMV2-5 (12 fentes)		
36	537D8097	786389	1	 Tube de combustion BMV2 (F)		
37	5476A030	786476	1	 Passe-fil câble allumage BMV		
38	A1002666		1	Axe commande réglage d'air BMV		
39	537D8115		1	Clame rouge réglage d'air BMV		
40	537D8116	910438	1	Clame noire réglage d'air BMV		



BMV 1-2 (->2012)

Code	Code GA	Quant.	Photo	Description	De --- A ---	Remarque
41	537D8149	1		Raccord préchauffeur BMV		
42	537D8093	786387	1	Capot noir brûleur BMV		
99	537D8159	786412	1	 Réduction 80/50 BMV1 FV		For FV
113	A1007560	780396	1	Cellule BMV1-5 (10011.00105)	01-02-20-	Only for LMO burner control
116	54768021	785253	1	 Automate brûleur BMR31-33-BMe1	11-02-20-	LMO14.11CHA