



Electromotoric Actuators

for slipper valves with 90° angle of rotation

SQK34.00

SQK84.00

- **SQK34.00** operating voltage AC 230 V
- **SQK84.00** operating voltage AC 24 V
- 3-position control signal
- Nominal angle of rotation 90°
- Nominal torque 5 Nm
- For direct assembly with no need of mounting kit
- 1 auxiliary switch for extra functions
- Manual adjuster and position indicator
- Mode of operation «AUTO» or «MAN»
- Reversible electromotoric actuator

Use

For use in heating, ventilation and air conditioning systems to operate type VBF21..., VBG31..., VBI31..., VCI31.. 3-port and 4-port slipper valves up to DN 50 (refer to «Equipment combinations»).

Type summary

Type	Operating voltage	Positioning signal	Positioning time for 90° at 50 Hz	Torque
SQK34.00	AC 230 V	3-position	135 s	5 Nm
SQK84.00	AC 24 V			

Accessories

Type	Description
ASC9.7	Auxiliary switch



Order

The actuator and accessories must be ordered separately.
When ordering please specify the quantity, product name and type code.

Example

1 actuator SQK34.00
1 auxiliary switch ASC9.7

Delivery

The actuator and accessories are packed separately and delivered as individual items.

Spare parts, rev. no.

Overview see page 6.

Equipment combinations

	Slipper valves	Actuators SQK34.00, SQK84.00	Data sheet
3-port valve	VBF21.., Series 02	DN 40...50	N4241
	VBI31.., Series 02	DN 20...40 (¾...1½")	N4232
	VBG31.., Series 02		N4233
4-port valve	VCI31.., Series 02	DN 20...40 (¾...1½")	N4252

Function / mechanical design

These electromotoric actuators require no maintenance. They have a reversible synchronous motor.

The actuator is driven by a 3-position signal from the controller and generates a rotary motion which is transferred via a pin in the slipper valve shaft to the 3-port or 4-port slipper valve.

The actuators are supplied with a 90° angle of rotation. During automatic operation, rotation is limited by two built-in end-switches.

The direction of operation of the actuator can be reversed (refer to «Commissioning»).

Direction of rotation of the actuator on delivery:

- Voltage at Y1 = Counter-clockwise rotation (ccw)
- Voltage at Y2 = Clockwise rotation (cw)
- No voltage = No rotation; actuator fixed in relevant position

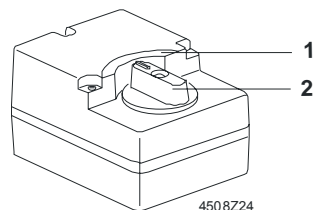

- 1 Position indicator, can be changed manually, depending on the required direction of rotation
- 2 Manual setting knob
When the selector is set to «MAN», the valve can be operated with a manual knob.



3 Selector for automatic or manual operation

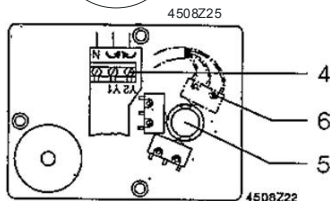

4 Connecting terminals

5 Coupling and cam shaft

6 Space for auxiliary switch

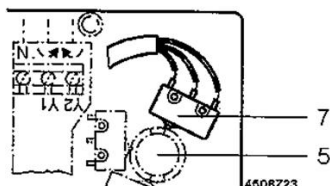

7 Auxiliary switch ASC9.7

For on / off changeover operation. The switching point is adjustable.

Factory-wired with a three-wire cable of 1.5 m.

Engineering notes

Electrical installation

The actuators must be electrically connected in accordance with local regulations and with the connection diagrams.



Regulations and requirements to ensure the safety of people and property must be observed at all times.

If additional functions are required, the actuator must be equipped with an auxiliary switch. The relevant switching point must be noted in the plant documentation

Mounting notes

Overview of
Mounting Instructions

Type	Mounting Instructions
SQK34.00, SQK84.00	M4508 74 319 0448 0

Type	Mounting Instructions
ASC9.7	G4508.1 4 319 5579 0

The valve and actuator can be assembled straightforwardly on site. There is no need for special tools.

Orientation

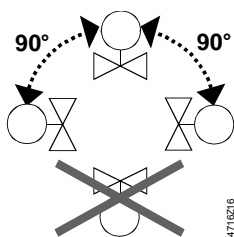

Commissioning notes

When commissioning the complete motorized valve consisting of actuator and slipper valve, always check the wiring and test the functions. This also applies to the additional auxiliary switch ASC9.7 fitted.

For automatic operation, the selector must be set to «AUTO»

Mode of operation



«AUTO» = automatic operation



«MAN» = manual operation

Position indication



Manual setting «**FULLY CLOSED**»
= no supply of heat *



Manual setting «**FULLY OPEN**»
= maximum supply of heat *

* If the hydraulic circuit is reverse, the removable scale for the position indication must be turned.

Direction of rotation

The actuators are factory-set to rotate in counter-clockwise (ccw) direction for opening. The direction of rotation of the actuator or the slipper valve is determined by the

- Boiler flow (from left or right)
- Position of the slipper valve (hydraulic circuit)

Reversing the direction of rotation

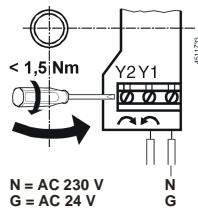

Control signal supplied to terminal **Y1**
= **counter-clockwise direction** (ccw)

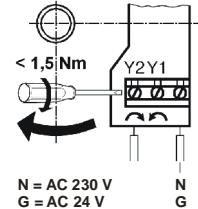

Control signal supplied to terminal **Y2**
= **clockwise direction** (cw)

The wiring connecting terminals Y1 and Y2 must be inverted if the direction of rotation is reversed. If an auxiliary switch is mounted, it must be taken into consideration when making the electrical connections.

Setting the angle of rotation

The angle of rotation is factory-set to 90° and cannot be adjusted.

Control

Every actuator must be driven by a dedicated controller.

Maintenance

The actuators require no maintenance.

Caution

Before performing any service work on the slipper valve or actuator:

- Switch off the pump and power supply
 - Close the main shut-off slipper valves in the pipework
 - Release pressure in the pipes and allow them to cool down completely
- If necessary, disconnect electrical connections from terminals.

The slipper valve must be re-commissioned only with the manual adjuster or the actuator correctly assembled.

Disposal



The device is considered an electronics device for disposal in terms of European Directive 2012/19/EU and may not be disposed of as domestic garbage.

- Dispose of the device through channels provided for this purpose.
- Comply with all local and currently applicable laws and regulations.

Warranty

The technical data given for these applications is valid only in conjunction with the Siemens butterfly and slipper valves as detailed under «Equipment combinations». The use of third-party slipper valves other than those recommended by Siemens invalidates the warranty.

Technical data

		SQK34.00	SQK84.00
Power supply	Operating voltage	AC 230 V, ± 15 %	AC 24 V, ± 20 %
	Frequency	50 / 60 Hz	
	Power consumption ¹⁾	3 VA	2 VA
Control	Positioning signal	3-position	
	Parallel operation	parallel operation of several actuators not possible	
Operating data	Positioning time for 90°	135 s	
	Angle of rotation	90° ± 3° (factory setting)	
	Torque ¹⁾	Starting torque	10 Nm
Nominal torque		5 Nm	
Norms and directives	Electromagnetic compatibility (Application)	For residential, commercial and industrial environments	
	Product standard	EN60730-x	
	EU Conformity (CE)	CE1T4508X1 ²⁾	
	RCM Conformity	A5W00006058 ²⁾	
	EAC Conformity	Eurasian conformity for all SQK..	
	Protection standard EN 60730	Class II	Class III
	Housing protection standard Upright to horizontal	IP42 to EN 60529	
	Environmental compatibility	The product environmental declaration CE1E4508en01 ²⁾ contains data on environmentally compatible product design and assessments (RoHS compliance, materials composition, packaging, environmental benefit, disposal).	
Dimensions / weight	Dimensions	see «Dimensions»	
	Cable glands	1 x Ø 20.5 mm (for M20)	
	Weight	0.5 kg	
Materials	Housing base, yoke	plastic	
	Cover	plastic	

¹⁾ These values apply at nominal voltage, at an ambient temperature of 20 °C and at the specified nominal running time

²⁾ The documents can be downloaded from <http://siemens.com/bt/download>.

Accessories for SQK34.00, SQK84.00

Auxiliary switch ASC9.7	Switching capacity	AC 250 V, 10 A resistive, 3 A inductive
-------------------------	--------------------	---

General ambient conditions	Operation	Transport	Storage
	EN 60721-3-3	EN 60721-3-2	EN 60721-3-1
Environmental conditions	Class 3K5	Class 2K3	Class 1K3
Temperature	-15...+50 °C	-30...+65 °C	-30...+65 °C
Humidity	5...95 % r. h.	< 95 % r. h.	0...95 % r. h.

Internal diagrams

SQK34.00

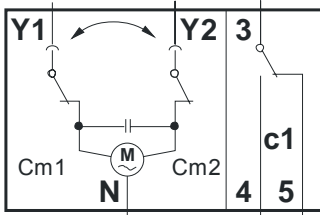

SQK84.00

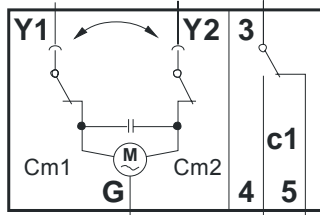

- Cm1 End switch
- Cm2 End switch
- c1 1 auxiliary switch **ASC9.7**
- N Neutral conductor
- G System potential
- Y1 Control signal counter-clockwise (ccw)
- Y2 Control signal clockwise (cw)

Dimensions

Dimensions in mm

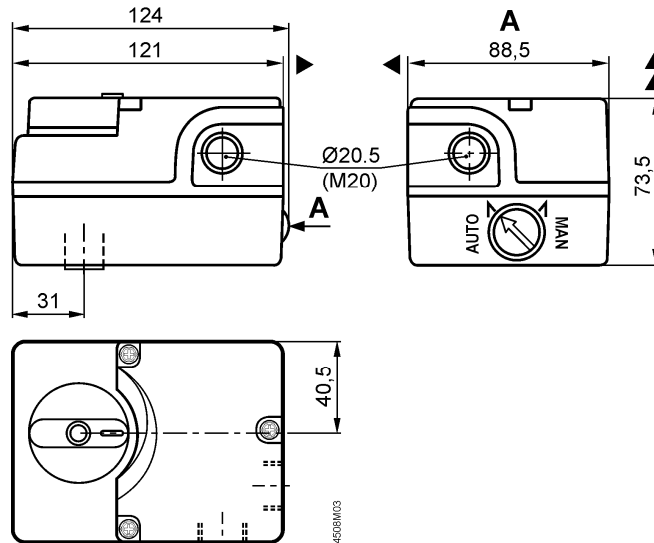

Overall height of valve and actuator

- = Installation height of slipper valve from the middle of the pipe
- + Installation height of the actuator
- + Minimum clearance from ceiling or wall for mounting, connection, operation, service etc.
 - ▶ > 100 mm
 - ▶▶ > 200 mm

Spare parts

Order number for spare parts

Type	Tappet bush
	
SQK34.00	417856708
SQK84.00	417856708

Revision number

Type	Rev. No, valid from
SQK34.00	..E
SQK84.00	..E

Issued by
Siemens Switzerland Ltd
Building Technologies Division
International Headquarters
Gubelstrasse 22
6301 Zug
Switzerland
Tel. +41 41-724 24 24
www.siemens.com/buildingtechnologies

© Siemens Switzerland Ltd, 2000
Technical specifications and availability subject to change without notice.