

Tab 419

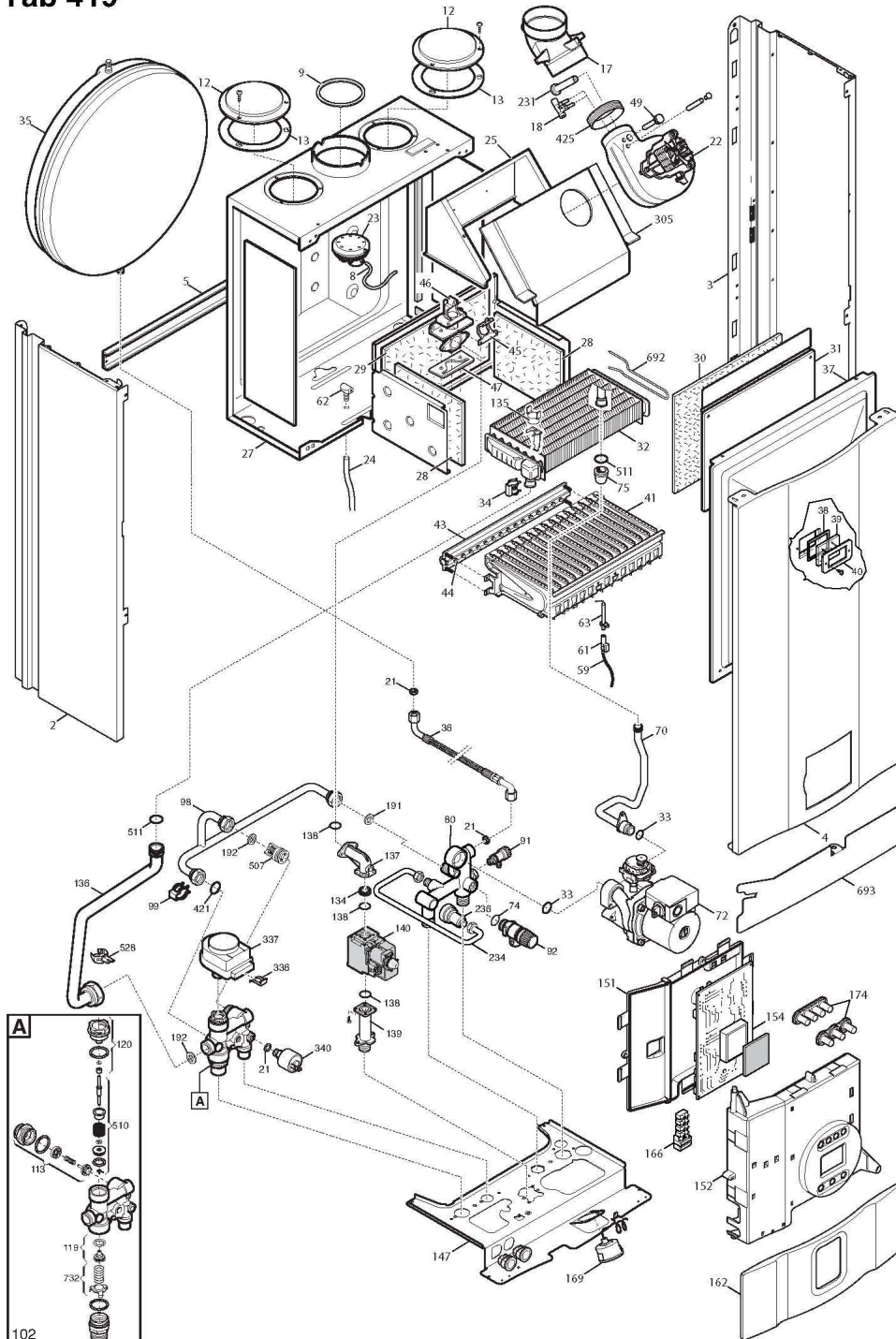

MS 24 FF

Réf.	Référence	Description	Qté	Tarif	Substitut	Tarif Sub.	Remarques
0	JJD00841	CABLE MISE A LA TERRE	1	1,00 €			[To Translat =]
0	JJD00851	FAISCEAU VENTILATEUR	1	8,70 €			[To Translat =]
0	JJD00841	PONT THERMOSTAT D'AMBIANCE	1	1,00 €			[To Translat =]
0	JJD00841	CABLE ALIMENTATION ELECTRIQL	1	3,40 €			[To Translat =]
0	JJD00851	FAISC.24V BOBINE VG-PRESSOST.	1	6,95 €			[To Translat =]
0	JJD00851	FAISCEAU 230V VG-MOTEUR V3V-(1	23,40 €			[To Translat =]
0	7617701	KIT JOINTS ZENA	1	64,80 €			[To Translat =]
0	JJD00511	ETRIER MURALE MS	1	6,50 €			[To Translat =]
0	710139500	PURGEUR CIRCULATEUR WILO	1	15,00 €			[To Translat =]
A	JJD71046	GROUPE HYDRAULIQUE CPL	1	63,00 €			
0	710493600	PURGEUR CIRCULATEUR GRUNDF	1	24,80 €			
2	JJD00569	PANNEAU COTE GAUCHE FF	1	26,90 €			
3	JJD00569	PANNEAU COTE DROIT FF	1	26,90 €			
4	JJD00063	PANNEAU AVANT	1	18,20 €			
5	JJD00511	TRAVERSE PANNEAU ARRIERE D'	1	1,15 €			
8	JJD00540	TUBE PRESSOSTAT	1	1,00 €			
9	JJD00511	DIAPHRAGME AIR D.78MM	1	1,90 €			
9	JJD00511	DIAPHRAGME AIR D.80mm	1	1,90 €			
9	JJD71073	DIAPHRAGME AIR D.90mm	1	1,90 €			
12	JJD00510	OBTURATEUR	1	1,00 €			
13	JJD00540	JOINT OBTURATEUR CAOUTCHOU	1	1,00 €			
17	JJD00521	COUDE EVACUATION FUMEE	1	6,50 €			
18	JJD00541	VENTURI	1	1,45 €			
21	JJD00540	JOINT VASE/DISCONNECTEUR 6,1)	1	1,00 €			
22	JJD00568	VENTILATEUR 57W MVL	1	52,30 €			
23	JJD00062	PRESSOSTAT FUMEEES 70-60PA HL	1		JJD721946	22,90 €	
24	JJD00541	TUBE DE PRESSION CAISSON	1	1,00 €			
25	JJD00511	SUPPORT EXTRACTEUR	1	6,20 €			
27	JJD00570	CAISSON ETANCHE FF	1	38,90 €			
28	JJD00521	ISOLATION LATERALE FOYER FF	1	2,05 €			
29	JJD00521	ISOLATION ARRIERE FOYER	1	4,10 €			
30	JJD00521	ISOLATION AVANT FOYER FF	1	4,60 €			
31	JJD00061	PANNEAU AVANT FOYER FF	1	7,50 €			
32	JJD00567	ECHANGEUR CHAUFFAGE	1	149,00 €			
33	JJD00540	JOINT TORIQUE 22X3 EPDM	1		JJD710963	1,00 €	
34	JJD00511	CLIP DE FIXATION TUBE DEPART	1	1,25 €			
35	JJD00569	VASE EXPANSION ROND 6L	1		JJD005693	47,60 €	
36	JJD71046	FLEXIBLE VASE D'EXPANSION	1	9,80 €			
37	JJD00566	COUVERCLE CAISSON ETANCHE	1	21,90 €			
38	JJD00540	JOINT VOYANT FF	1	1,00 €			
39	JJD00520	VOYANT FF	1	1,90 €			
40	JJD00510	BRIDE VOYANT FF	1	1,00 €			
41	JJD00566	BRULEUR 13 BECS	1	19,50 €			
43	JJD00569	NOURRICE+INJECTEUR 1.28 GN FF	1	20,20 €			
44	JJD00568	KIT INJECTEURS PROPANE	1	4,10 €			

MS 24 FF

45	JJD00540	JOINT NOURRICE-RACCORD	1	1,00 €		
46	JJD00565	RACCORD NOURRICE	1	6,50 €		
47	JJD00540	JOINT NOURRICE-TUBE SORTIE V/	1	1,00 €		
49	JJD00540	BOUCHON PRISE DE PRESSION	1	1,00 €		
59	JJD00861	CABLE ALLUMAGE LG.250MM	1		JJD710430	1,05 €
61	JJD00540	PROTECTION ELECTRODE	1	1,00 €		
62	JJD00540	RACCORD TUBE COMPENSATEUR	1	1,00 €		
63	JJD00842	ELECTRODE ALLUMAGE + IONISAT	1	2,50 €		
70	JJD71040	TUBE RETOUR ECHANGEUR FF	1	18,50 €		
72	JJD71039	CIRCULATEUR 2 VITESSES	1	139,00 €		
74	JJD00540	JOINT TORIQUE 14X1,78 EP-57092	1	1,00 €		
75	JJD00540	PASSE-TUBE DEPART / RETOUR	1	1,00 €		
80	JJD71046	GROUPE HYDRAULIQUE CPL	1	63,00 €		
91	JJD00565	ROBINET DE VIDANGE	1	4,20 €		
92	JJD00995	SOUPAPE DE SECURITE 3 BAR	1	20,20 €		
98	JJD00567	TUBE BY-PASS	1	12,50 €		
99	JJD00838	CLIP PRESSOSTAT MANQUE EAU	1	1,00 €		
102	JJD00568	VANNE 3 VOIES COMPLETE	1	90,80 €		
113	JJD00061	CLAPET ANTI-RETOUR BY-PASS V/	1	15,10 €		
119	JJD00060	CLAPET ANTI-RETOUR BY-PASS	1	6,90 €		
120	JJD00060	BOUCHON VANNE 3 VOIES	1	23,60 €		
134	JJD71049	DIAPHRAGME GAZ D.4,8mm	1	2,05 €		
135	JJD00995	THERMOSTAT DE SECURITE 105°C	1	2,95 €		
136	JJD00567	TUBE DEPART ECHANGEUR FF	1	14,90 €		
137	JJD71039	TUBE VANNE GAZ-NOURRICE FF	1	9,25 €		
138	JJD00540	JOINT TORIQUE 22,22X2,62	1	1,00 €		
139	JJD00520	TUBE ARRIVEE GAZ	1	7,60 €		
140	JJD00565	VANNE GAZ (SIT 845 SIGMA)	1	67,90 €		
147	JJD00569	PANNEAU INFERIEUR GROUPE HY	1	8,80 €		
151	JJD00541	COUVERCLE ARRIERE TABLEAU	1		JJD000631	4,10 €
152	JJD71039	COUVERCLE AVANT TABLEAU	1	10,00 €		
154	JJD71046	CARTE ELECTRONIQUE	1		JJJ0057024	88,40 €
162	JJD71039	ENJOLIVEUR DE DIETRICH	1	7,25 €		
166	JJD00568	BARRETTE CONNEXION 5 POLES	1	4,20 €		
169	JJD00995	MANOMETRE AVEC SUPPORT	1	9,80 €		
174	JJD00062	CLAVIER ELASTOMERE 3 ET 4 BOL	1	3,50 €		
191	JJD00540	JOINT G1/2"	1	1,00 €		
192	JJD00540	JOINT G3/4-17X24X2	1		JJJ0054046	Nous consulter ...
231	JJD00540	RACCORD PRISE DE PRESSION	1	1,35 €		
234	JJD00565	TUBE DISCONNECTEUR	1	6,15 €		
236	JJD71087	DISCONNECTEUR+JTS+TUBES MS	1		JJD711121	67,60 €
305	JJD00511	COUVERCLE SUPPORT EXTRACTE	1	4,50 €		
336	JJD00838	CLIP FIXATION MOTEUR VANNE 3 \	1	1,00 €		
337	JJD71018	MOTEUR VANNE 3 VOIES	1		JJD005694	24,40 €
340	JJD00995	PRESSOSTAT MANQUE EAU	1	7,85 €		
421	JJD00540	JOINT TORIQUE D.11,91X2,62 EPDI	1	1,00 €		
425	JJD00541	JOINT VENTURI	1	1,00 €		
507	JJD00060	CLAPET ANTI-RETOUR BY-PASS	1	13,80 €		
510	JJD00060	CLAPET ANTI-RETOUR ECS	1	16,50 €		
511	JJD00540	JOINT TORIQUE D.17,86X2,62 EPDI	1	1,00 €		

MS 24 FF

528	JJD00843	SONDE DEPART CHAUFFAGE	1	4,30 €		
692	JJD00511	CLIP ECHANGEUR CHAUFFAGE	1	1,05 €		
693	JJD00511	PLAQUE PROTECTION TABLEAU D	1		710471300	Nous consulter ...
732	JJD00062	RESSORT	1	7,85 €		

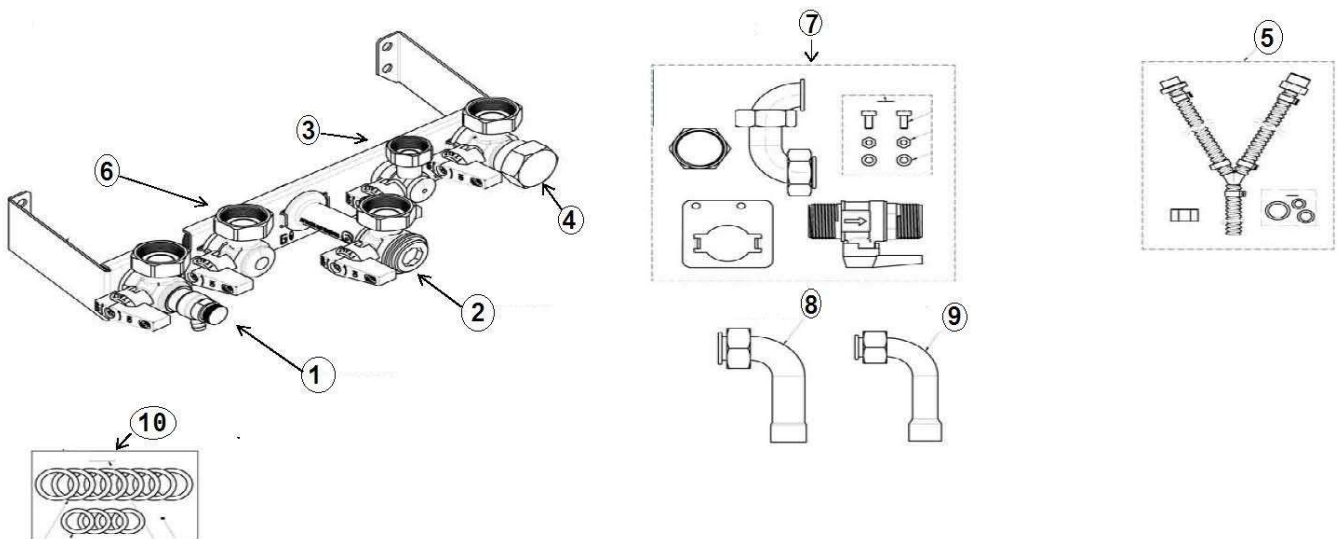

MS 24 FF

Réf.	Référenc	Description	Qté	Tarif	Substitut	Tarif Sub.	Remarques
1	JJD71045	ROBINET DEPART CHAUFFAGE	1	19,50 €			
2	JJD71037	ROBINET GAZ	1	18,80 €			
3	JJD71022	ROBINET ENTREE SANITAIRE G1/2	1	11,50 €			
4	JJD71007	ROBINET RETOUR CHAUFFAGE	1	14,80 €			
5	JJD71046	TUYAU EVACUATION CONDENSAT	1		7647520	18,40 €	
6	JJD71039	ROBINET CHAUFFAGE/BALLON	1	20,80 €			
7	JJD71066	ROBINET EXTERIEUR	1	22,10 €			
8	JJD71040	TUBE D.18mm	1	5,00 €			
9	JJD71040	TUBE D.14mm	1	3,90 €			
10	JJD00363	KIT JOINTS	1	1,60 €			

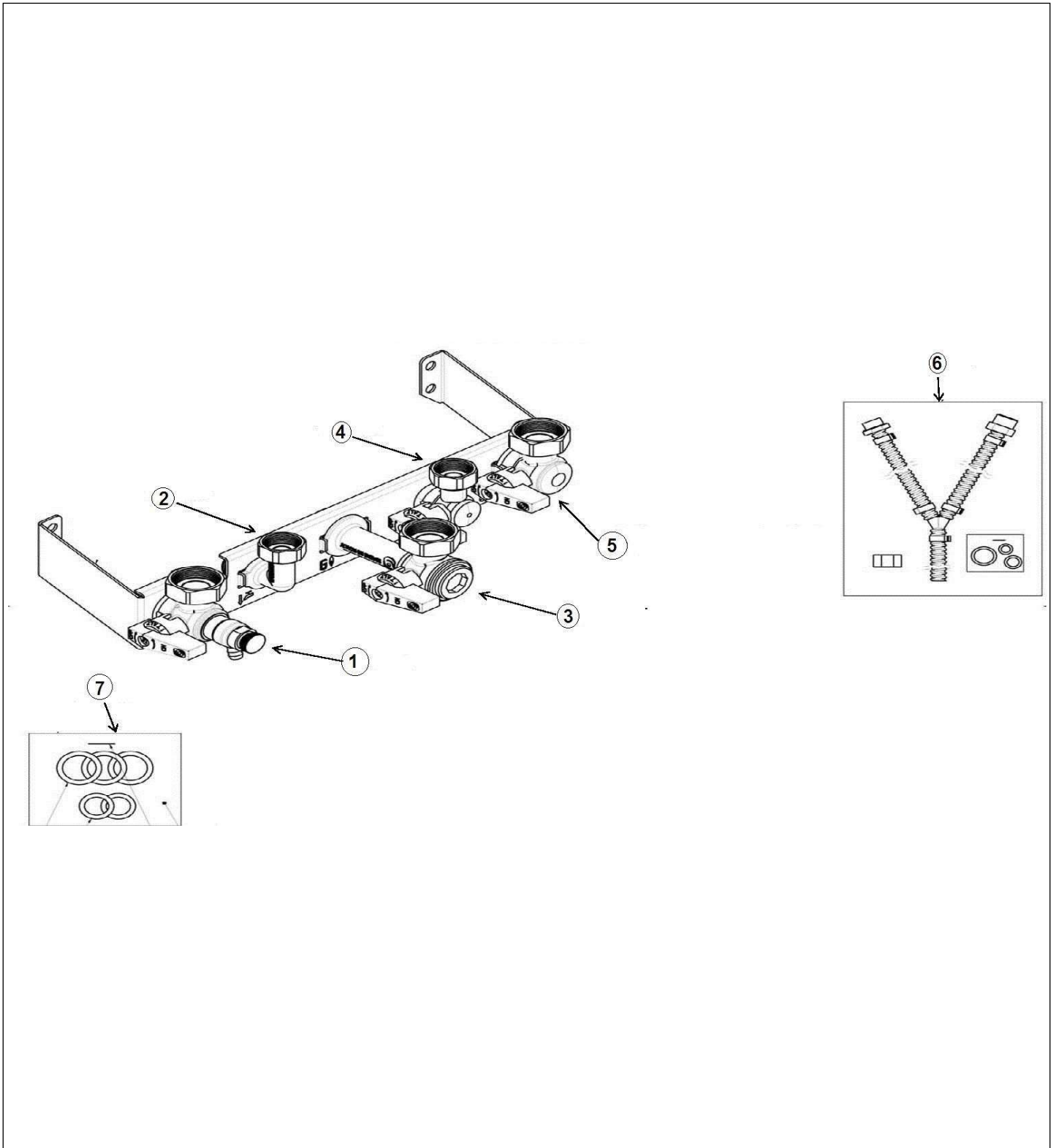

MS 24 FF

Réf.	Référenc	Description	Qté	Tarif	Substitut	Tarif Sub.	Remarques
0	JJJ005210	BOUCHON 3/4"	1	5,10 €			
1	JJD71045	ROBINET DEPART CHAUFFAGE	1	19,50 €			
2	JJD71007	COUDE DEPART ECS	1	5,60 €			
3	JJD71037	ROBINET GAZ	1	18,80 €			
4	JJD71022	ROBINET ENTREE SANITAIRE G1/2	1	11,50 €			
5	JJD71007	ROBINET RETOUR CHAUFFAGE	1	14,80 €			
6	JJD71046	TUYAU EVACUATION CONDENSAT	1		7647520	18,40 €	
7	JJD71035	KIT JOINTS	1	1,00 €			

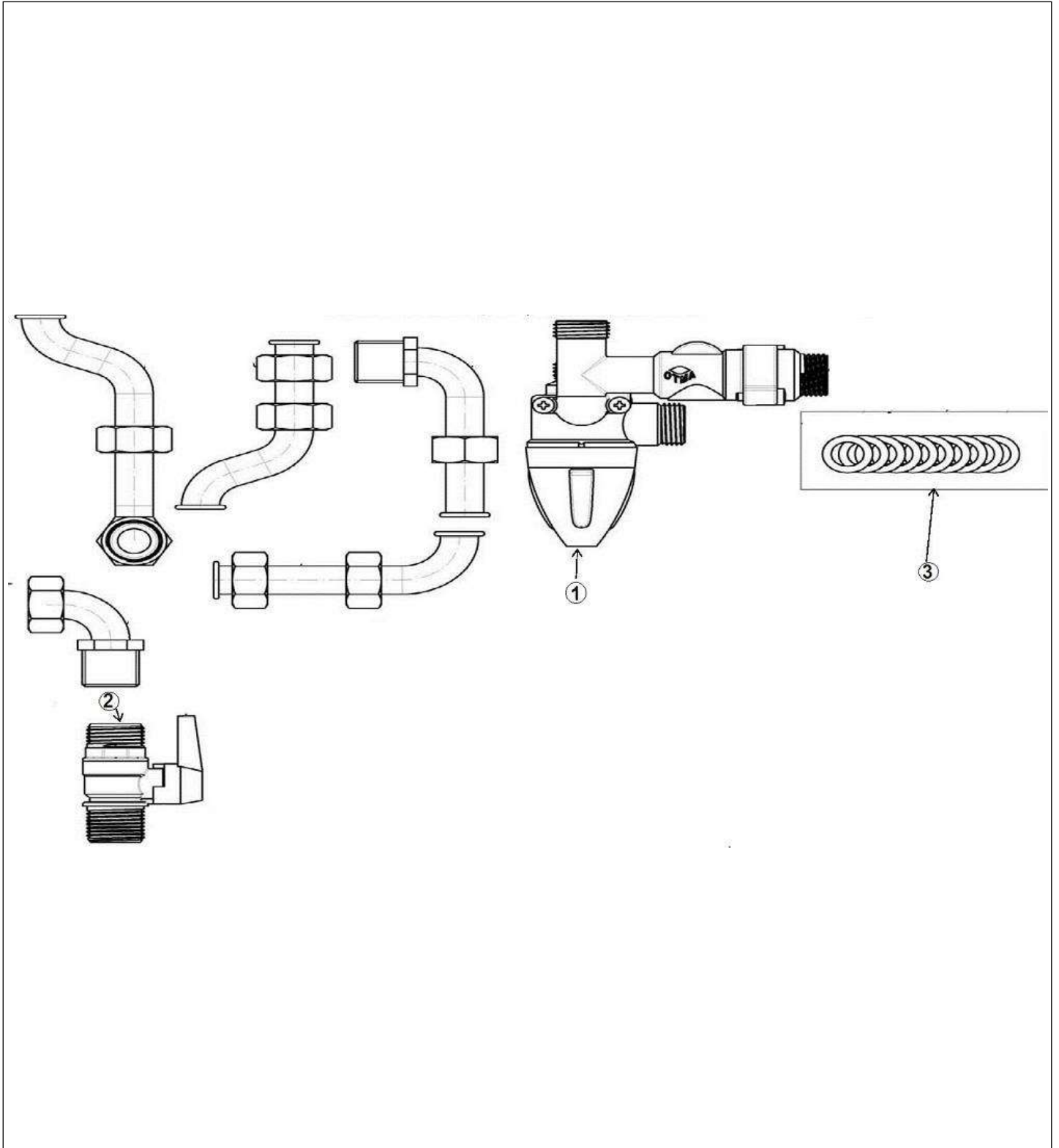

MS 24 FF

Réf.	Référenc	Description	Qté	Tarif	Substitut	Tarif Sub.	Remarques
1	JJD00569	VALVE MITIGEUR	1	164,00 €			
2	JJD00362	ROBINET G1/2"	1	12,50 €			
3	JJD00362	KIT JOINTS	1	1,15 €			

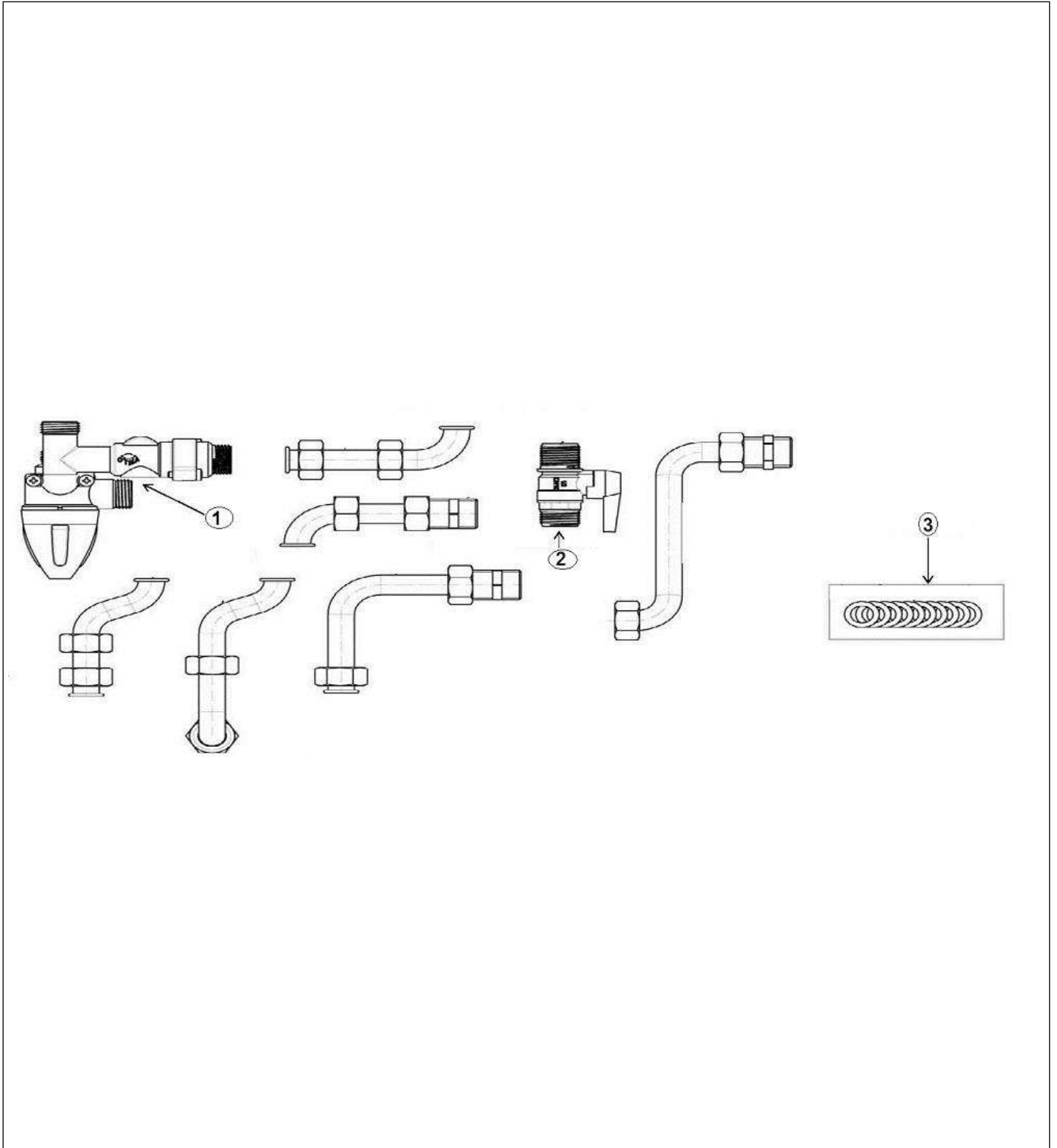

MS 24 FF

Réf.	Référenc	Description	Qté	Tarif	Substitut	Tarif Sub.	Remarques
1	JJD00569	VALVE MITIGEUR	1	164,00 €			
2	JJD00362	ROBINET G1/2"	1	12,50 €			
3	JJD00362	KIT JOINTS	1	1,15 €			

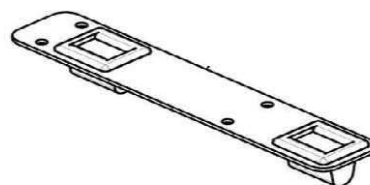
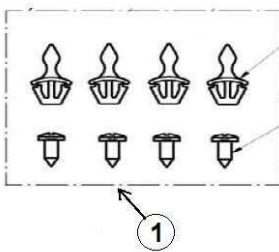
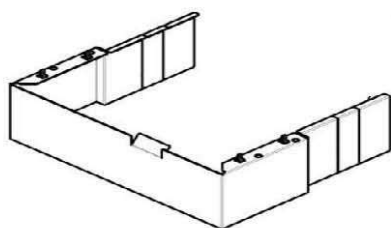

Tab 5

MS 24 FF

Réf.	Référenc	Description	Qté	Tarif	Substitut	Tarif Sub.	Remarques
1	JJD71055	KIT CLIPS	1	1,25 €			