

**MS 24 PLUS**

Réf.	Référenc	Description	Qté	Tarif	Substituit	Tarif Sub.	Remarques
0	JJD00841	PONT THERMOSTAT D'AMBIANCE		1,00 €			[To Translat = ]
0	JJD00841	CABLE ALIMENTATION ELECTRIQL		3,40 €			[To Translat = ]
0	JJD00841	CABLE MISE A LA TERRE		1,00 €			[To Translat = ]
0	JJD00851	FAISC.24V SONDÉ CH-THERMOST.		8,55 €			[To Translat = ]
0	JJD00851	FAISC.24V BOBINE VG-PRESSOST.		6,95 €			[To Translat = ]
0	JJD71086	CABLAGE		16,50 €			[To Translat = ]
0	JJD72190	CABLAGE CIRCULATEUR GRUNDF		17,60 €			[To Translat = ]
A	JJD71046	GROUPE HYDRAULIQUE CPL	1	63,00 €			
2	JJD71070	PANNEAU LATERAL GAUCHE	1	28,50 €			
3	JJD71070	PANNEAU LATERAL DROIT		29,30 €			
4	JJD00063	PANNEAU AVANT		18,20 €			
5	JJD00511	TRAVERSE PANNEAU ARRIERE D'		2,05 €			
27	JJD00567	PANNEAU ARRIERE CHAMBRE COI		27,00 €			
28	JJD00521	ISOLATION LATERALE FOYER		1,50 €			
29	JJD00521	ISOLATION ARRIERE FOYER		4,10 €			
30	JJD00521	ISOLATION AVANT FOYER		4,00 €			
31	JJD00061	PANNEAU AVANT FOYER		7,85 €			
32	JJD00567	ECHANGEUR CHAUFFAGE		149,00 €			
33	JJD71096	JOINT 21,5X3 EP70 TFL		1,00 €			
34	JJD00511	CLIP DE FIXATION TUBE DEPART		1,25 €			
35	JJD00569	VASE EXPANSION RECT. 6L		59,00 €			
36	JJD71046	FLEXIBLE VASE D'EXPANSION		9,80 €			
41	JJD00566	BRULEUR 13 BECS		19,50 €			
43	JJD00569	NOURRICE+INJECTEUR 1.18 GN CI		17,10 €			
44	JJD00566	KIT INJECTEURS GAZ NATUREL CH		3,65 €			
44	JJD00568	KIT INJECTEURS PROPANE		4,10 €			[To Translat = ]
45	JJD00540	JOINT NOURRICE-RACCORD		1,00 €			
46	JJD00565	RACCORD NOURRICE		6,50 €			
59	JJD71043	CABLE ALLUMAGE + RESIST.LG. 2€		1,05 €			
61	JJD00540	PROTECTION ELECTRODE		1,00 €			
63	JJD00842	ELECTRODE ALLUMAGE + IONISAT		2,50 €			
70	JJD71040	TUBE RETOUR ECHANGEUR CH		17,30 €			
72	JJD72218	CIRCULATEUR UMP 15-60 6M AVEC		194,00 €			
74	JJD00540	JOINT TORIQUE 14X1,78 EP-57092		1,00 €			
80	JJD71046	GROUPE HYDRAULIQUE CPL		63,00 €			
81	JJD71010	ENS. FILTRE ECS+TURBINE+LIMITI		23,10 €			[To Translat = ]
91	JJD00565	ROBINET DE VIDANGE		4,20 €			
92	JJD00995	SOUPAPE DE SECURITE 3 BAR		20,20 €			
98	JJD00567	TUBE BY-PASS		12,50 €			
99	JJD00838	CLIP PRESSOSTAT MANQUE EAU		1,00 €			
102	JJD00568	VANNE 3 VOIES COMPLETE		90,80 €			
113	JJD00061	CLAPET ANTI-RETOUR BY-PASS V/		15,10 €			
119	JJD00060	CLAPET ANTI-RETOUR BY-PASS		6,90 €			
120	JJD00060	BOUCHON VANNE 3 VOIES		23,60 €			
134	JJD00521	DIAPHRAGME GAZ D.5,5mm		4,30 €			

MS 24 PLUS

135	JJD00995	THERMOSTAT DE SECURITE 105°C	2,95 €		
136	JJD00567	TUBE DEPART ECHANGEUR	11,30 €		
137	JJD71039	TUBE VANNE GAZ-NOURRICE CH	10,00 €		
138	JJD00540	JOINT TORIQUE 22,22X2,62	1,00 €		
139	JJD00520	TUBE ARRIVEE GAZ	7,60 €		
140	JJD00565	VANNE GAZ (SIT 845 SIGMA)	67,90 €		
147	JJD71054	TRAVERSE	21,30 €		
151	JJD00063	COUVERCLE ARRIERE TABLEAU	4,10 €		
152	JJD71039	COUVERCLE AVANT TABLEAU	10,00 €		
154	JJD71105	CARTE ELECTRONIQUE SM11472		JJJ0057024	88,40 €
162	JJD71039	ENJOLIVEUR DE DIETRICH	7,25 €		
166	JJD00568	BARRETTE CONNEXION 5 POLES	4,20 €		
169	JJD00995	MANOMETRE AVEC SUPPORT	9,80 €		
174	JJD00062	CLAVIER ELASTOMERE 3 ET 4 BOL	3,50 €		
191	JJD00540	JOINT G1/2"	1,00 €		
192	JJD00540	JOINT G3/4-17X24X2		JJJ0054046	Nous consulter ...
234	JJD00565	TUBE DISCONNECTEUR	6,15 €		
236	JJD71112	DISCONNECTEUR+JTS+TUBES MS	67,60 €		
241	JJD71039	ANTIREFOULEUR	44,90 €		
242	JJD00061	THERMOSTAT ANTIREFOULEUR 7C	3,75 €		
336	JJD00838	CLIP FIXATION MOTEUR VANNE 3 \	1,00 €		
337	JJD00569	MOTEUR VANNE 3 VOIES ELBI	24,40 €		
340	JJD00995	PRESSOSTAT MANQUE EAU	7,85 €		
421	JJD00540	JOINT TORIQUE D.11,91X2,62 EPDI	1,00 €		
507	JJD00060	CLAPET ANTI-RETOUR BY-PASS	13,80 €		
510	JJD00060	CLAPET ANTI-RETOUR ECS	16,50 €		
511	JJD00540	JOINT TORIQUE D.17,86X2,62 EPDI	1,00 €		
528	JJD00843	SONDE DEPART CHAUFFAGE	4,30 €		
692	JJD00511	CLIP ECHANGEUR CHAUFFAGE	1,05 €		
693	JJD00511	PLAQUE PROTECTION TABLEAU D		710471300	Nous consulter ...
732	JJD00062	RESSORT	7,85 €		

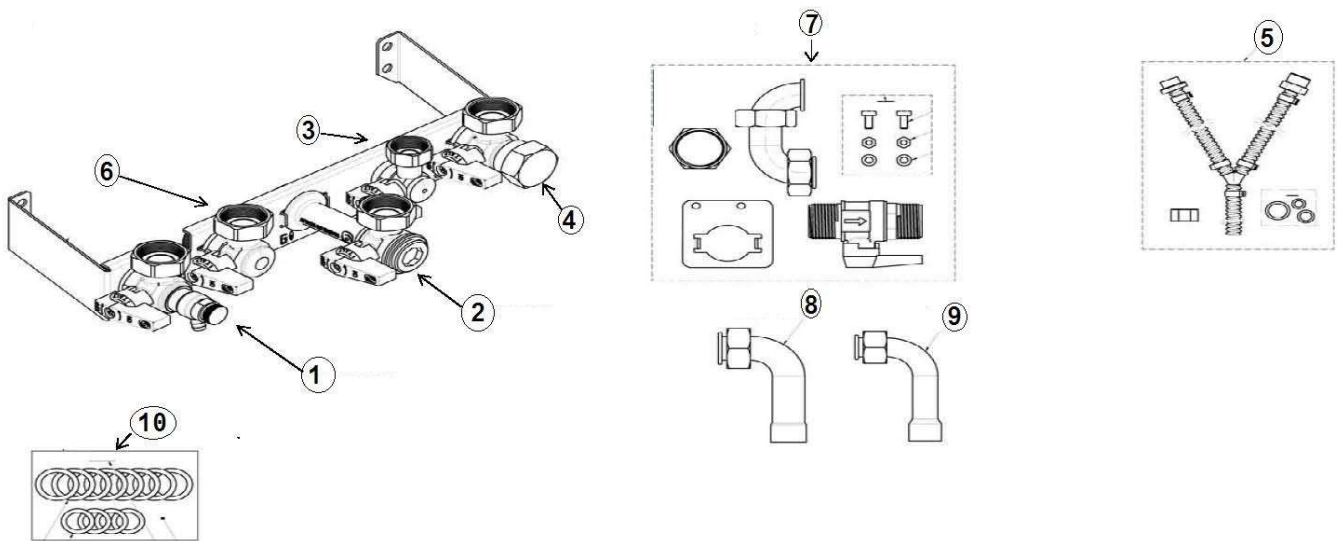

**MS 24 PLUS**

Réf.	Référenc	Description	Qté	Tarif	Substitut	Tarif Sub.	Remarques
1	JJD71045	ROBINET DEPART CHAUFFAGE	1	19,50 €			
2	JJD71037	ROBINET GAZ	1	18,80 €			
3	JJD71022	ROBINET ENTREE SANITAIRE G1/2	1	11,50 €			
4	JJD71007	ROBINET RETOUR CHAUFFAGE	1	14,80 €			
5	JJD71046	TUYAU EVACUATION CONDENSAT	1		7647520	18,40 €	
6	JJD71039	ROBINET CHAUFFAGE/BALLON	1	20,80 €			
7	JJD71066	ROBINET EXTERIEUR	1	22,10 €			
8	JJD71040	TUBE D.18mm	1	5,00 €			
9	JJD71040	TUBE D.14mm	1	3,90 €			
10	JJD00363	KIT JOINTS	1	1,60 €			

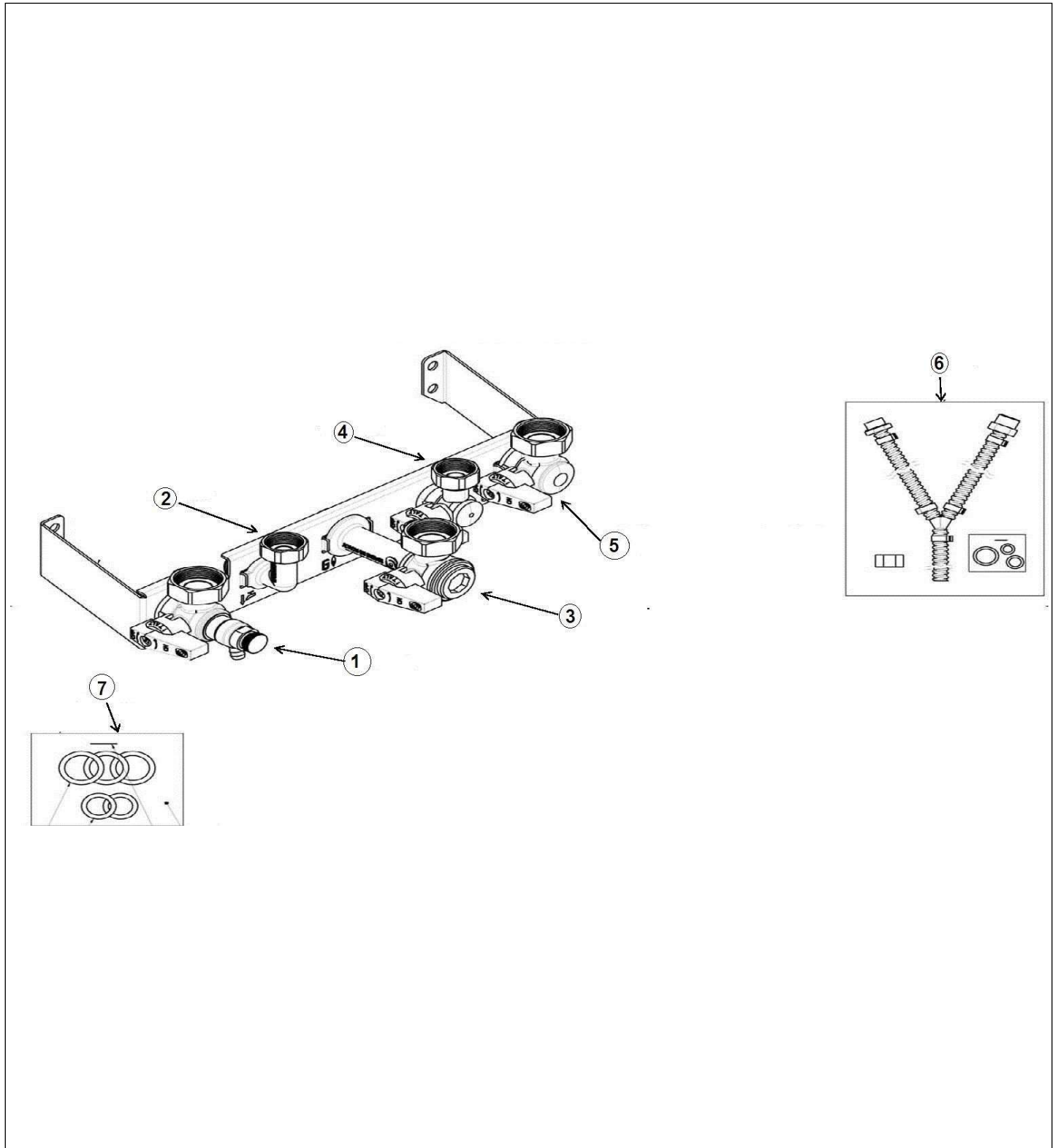

**MS 24 PLUS**

Réf.	Référenc	Description	Qté	Tarif	Substitut	Tarif Sub.	Remarques
0	JJJ005210	BOUCHON 3/4"	1	5,10 €			
1	JJD71045	ROBINET DEPART CHAUFFAGE	1	19,50 €			
2	JJD71007	COUDE DEPART ECS	1	5,60 €			
3	JJD71037	ROBINET GAZ	1	18,80 €			
4	JJD71022	ROBINET ENTREE SANITAIRE G1/2	1	11,50 €			
5	JJD71007	ROBINET RETOUR CHAUFFAGE	1	14,80 €			
6	JJD71046	TUYAU EVACUATION CONDENSAT	1		7647520	18,40 €	
7	JJD71035	KIT JOINTS	1	1,00 €			

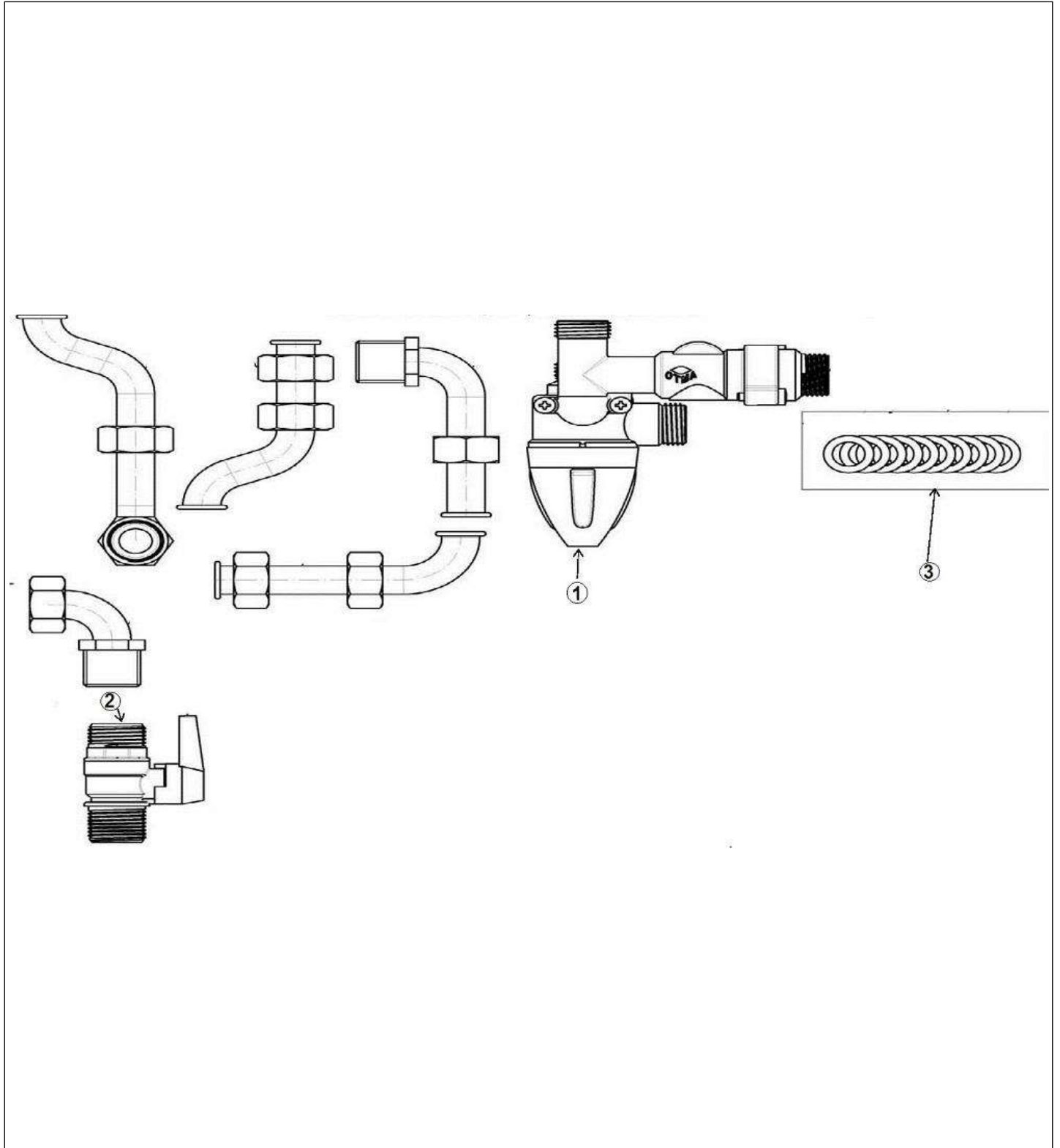



MS 24 PLUS

Réf.	Référenc	Description	Qté	Tarif	Substitut	Tarif Sub.	Remarques
1	JJD00569	VALVE MITIGEUR	1	164,00 €			
2	JJD00362	ROBINET G1/2"	1	12,50 €			
3	JJD00362	KIT JOINTS	1	1,15 €			

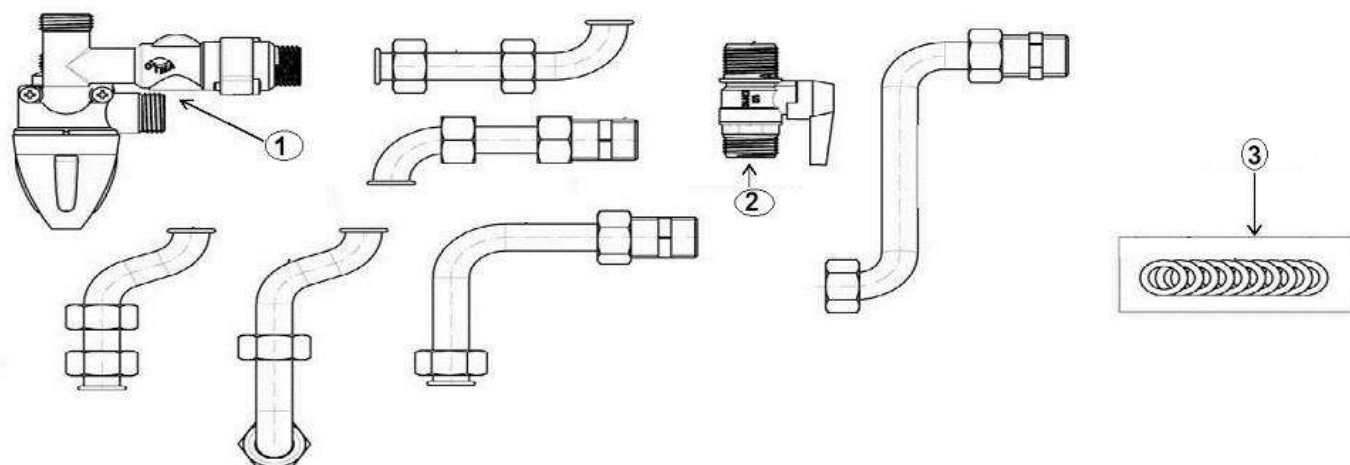

**MS 24 PLUS**

Réf.	Référenc	Description	Qté	Tarif	Substitut	Tarif Sub.	Remarques
1	JJD00569	VALVE MITIGEUR	1	164,00 €			
2	JJD00362	ROBINET G1/2"	1	12,50 €			
3	JJD00362	KIT JOINTS	1	1,15 €			

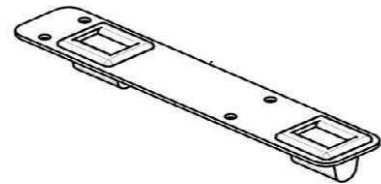
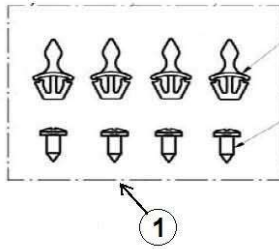
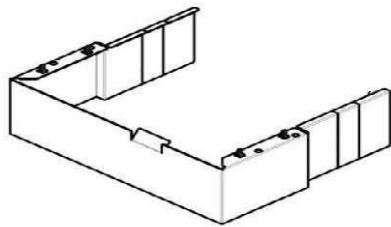

Tab 5

MS 24 PLUS

Réf.	Référenc	Description	Qté	Tarif	Substitut	Tarif Sub.	Remarques
1	JJD71055	KIT CLIPS	1	1,25 €			