

Tab 430

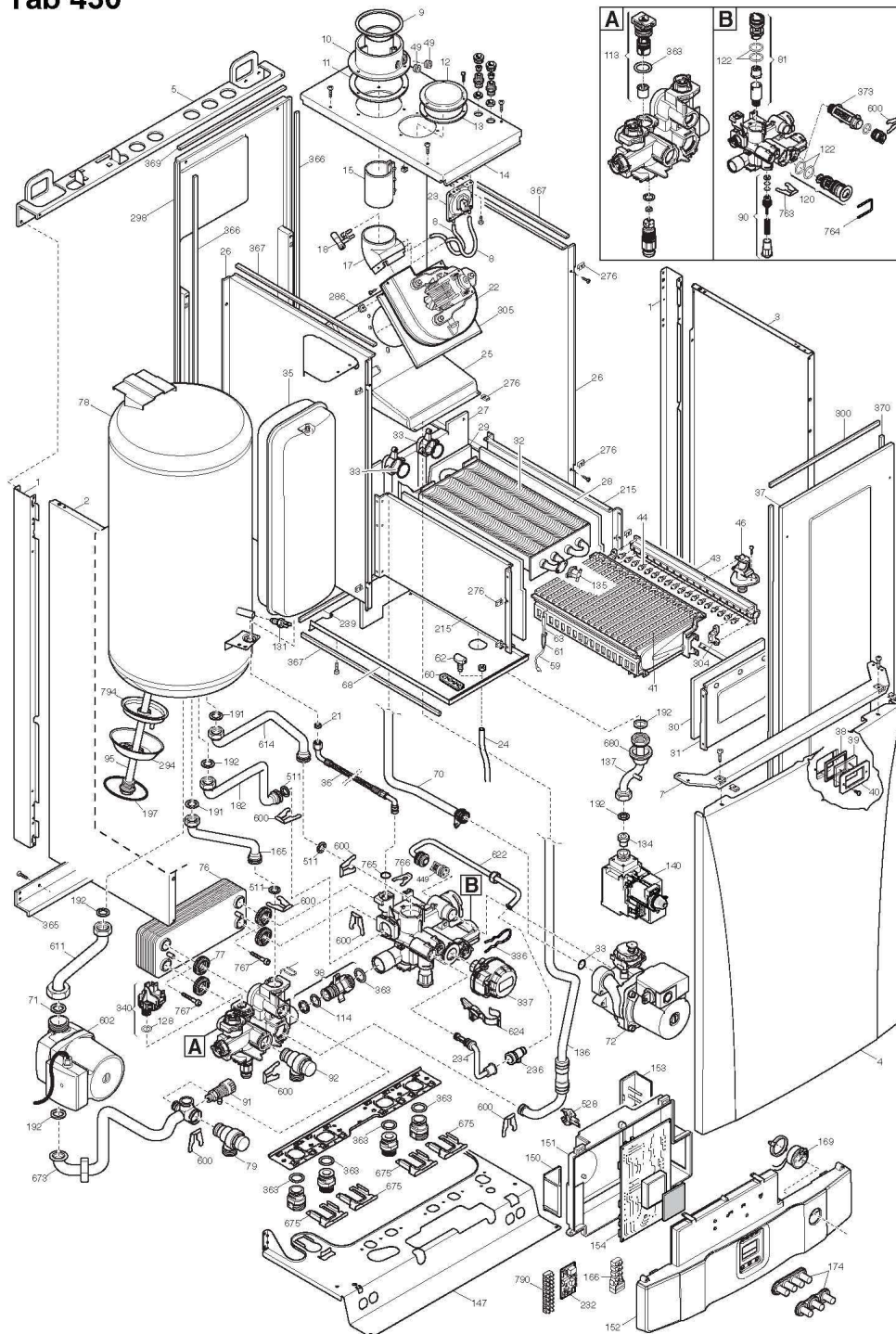

MS 24 BIC FF

Réf.	Référence	Description	Qté	Tarif	Substitué	Tarif Sub.	Remarques
0	JJD71058	BLOC HYDRAULIQUE MS BIC	1	287,00 €			
0	JJD71040	FAISCEAU MISE A LA MASSE	1	1,75 €			
0	JJD71050	FAISCEAU RALLONGE SONDE DHV	1	8,15 €			
0	JJD71054	FAISC.24V SONDES ECS-CAPTEUF	1	12,40 €			
0	JJD71054	FAISCEAU 230V VG-MOTEUR V3V-C	1	30,30 €			
0	JJD71039	FAISCEAU SONDES FF	1	10,30 €			
0	JJD71039	FAISCEAU VENTILATEUR	1	9,15 €			
0	JJD71029	DOUILLE LAITON 20,7/14x27	1	8,10 €			
0	710048000	EPINGLE TUBE DISCO U D.2MM	1		JJD711275	1,00 €	
0	7617701	KIT JOINTS ZENA	1	64,80 €			
0	710139500	PURGEUR CIRCULATEUR WILO	1	15,00 €			
0	JJD71004	BOUCHON + JOINT TUBE SORTIE E	1	3,65 €			
0	JJD71004	RESSORT PLAT D.12mm	1	1,00 €			
0	710493600	PURGEUR CIRCULATEUR GRUNDF	1	24,80 €			
1	JJD00511	CHASSIS MONTANT VERTICAL	1	7,85 €			
2	JJD00062	PANNEAU LATERAL GAUCHE	1	28,80 €			
3	JJD00062	PANNEAU LATERAL DROIT	1	28,80 €			
4	JJD00511	PANNEAU AVANT	1	48,00 €			
5	JJD00510	TRAVERSE ARRIERE SUPERIEURE	1	6,95 €			
7	JJD00510	TRAVERSE AVANT SUPERIEURE	1	2,65 €			
8	JJD00540	TUBE SILICONE PRESSOSTAT LG.6	1		JJJ0054022	Nous consulter ...	
9	JJD00062	REDUCT.ASPIRATION-DIAPHR D.7	1	2,35 €			
10	JJD00520	BRIDE DE RACCORDEMENT	1	11,40 €			
11	JJD00540	JOINT BRIDE DE RACCORDEMENT	1	1,20 €			
12	JJD00510	OBTURATEUR	1	1,00 €			
13	JJD00540	JOINT OBTURATEUR CAOUTCHOU	1	1,00 €			
14	JJD00565	PANNEAU SUPERIEUR CAISSON	1	30,60 €			
15	JJD00564	JOINT SORTIE VENTILATEUR	1	8,20 €			
17	JJD00060	COUDE 45°	1	9,15 €			
18	JJD00540	VENTURI	1	1,45 €			
21	JJD00540	JOINT VASE/DISCONNECTEUR 6,1)	1	1,00 €			
22	JJD00563	VENTILATEUR 1V 61W 230V	1	68,70 €			
23	JJD00062	PRESSOSTAT 115-95Pa HUBA	1		JJD710790	17,80 €	
23	JJD00062	PRESSOSTAT HONEYWELL 1,2mba	1	95,70 €			
24	JJD00540	TUBE SILICONE 4,5X8 LG.300 AR	1	1,10 €			
25	JJD00563	ANTIREFOULEUR	1	22,70 €			
26	JJD00510	PANNEAU LATERAL CAISSON	1	17,80 €			
27	JJD00510	PANNEAU ARRIERE CAISSON	1	3,40 €			
28	JJD00521	ISOLATION LATERALE CAISSON	1	8,05 €			
29	JJD00521	ISOLATION ARRIERE CAISSON	1	3,90 €			
30	JJD00521	ISOLATION AVANT CAISSON	1	3,75 €			
31	JJD00510	PANNEAU AVANT FOYER	1	4,30 €			
32	JJD00564	ECHANGEUR CHAUFFAGE	1	344,00 €			
33	JJD00540	JOINT TORIQUE 22X3 EPDM	1		JJD710963	1,00 €	
35	JJD00562	VASE EXPANSION 7.5L	1	51,00 €			
36	JJD71060	TUBE VASE D'EXPANSION	1	7,95 €			
37	JJD00562	PANNEAU AVANT CAISSON	1		JJD710706	24,00 €	
38	JJD00540	JOINT VOYANT FF	1	1,00 €			
39	JJD00520	VOYANT FF	1	1,90 €			

MS 24 BIC FF

40	JJD00511	BRIDE VOYANT	1	1,00 €		
41	JJD00563	BRULEUR 18 BECS	1	47,80 €		
43	JJD00563	RAMPE INJECTEUR D.1,18	1	26,50 €		
44	JJD00520	INJECTEUR D.1,18	1	1,00 €		
46	JJD00060	RACCORD NOURRICE	1	9,60 €		
49	JJD00520	BOUCHON PRISE DE MESURE	1	1,50 €		
59	JJD71040	CABLE D'ALLUMAGE	1	3,15 €		
60	JJD00540	JOINT ELECTRODE D'ALLUMAGE	1	1,05 €		
61	JJD00540	PROTECTION ELECTRODE	1	1,00 €		
62	JJD00540	RACCORD TUBE COMPENSATEUR	1	1,00 €		
63	JJD00842	ELECTRODE ALLUMAGE + IONISAT	1	2,50 €		
68	JJD00061	PLAQUE INFERIEURE FOYER	1	10,10 €		
70	JJD71029	TUBE POMPE - ECHANGEUR	1	36,00 €		
71	JJD00540	JOINT G1 22X30,3X2-WRC	1	1,00 €		
72	JJD71039	CIRCULATEUR 2 VITESSES	1	139,00 €		
76	JJD00568	ECHANGEUR A PLAQUES (20 PLAC	1	79,60 €		
77	JJD00540	JOINT ECHANGEUR A PLAQUES	1	1,00 €		
78	JJD71061	BALLON ISOLE	1	695,00 €		
79	JJD71061	SOUPAPE DE SECURITE 7 BAR NO	1	16,80 €		
81	JJD71073	ENS.FILTRE ECS+TURB.+LIMIT.DEI	1	23,10 €		
90	JJD71004	ROBINET DE REMPLISSAGE	1		7692261	12,50 €
91	JJD00565	ROBINET DE VIDANGE	1	4,20 €		
92	JJD71007	SOUPAPE DE SECURITE 3 BAR MI	1	7,75 €		
95	JJD00567	ANODE MAGNESIUM	1	23,30 €		
98	JJD71004	TUBE BY-PASS MI	1	6,95 €		
113	JJD71004	CLAPET ANTI-RETOUR BY-PASS M	1	7,95 €		
114	JJD71004	JOINT TORIQUE D.15,54X2,62	1	1,00 €		
120	JJD71014	CARTOUCHE VANNE 3 VOIES	1		JJD721403	29,10 €
122	JJD71004	JOINT TORIQUE D.23,47X2,62	1	1,00 €		
128	JJD71004	JOINT TORIQUE D.8,9X1,9	1	1,00 €		
131	JJD00843	SONDE NTC	1	28,20 €		
134	JJD00995	DIAPHRAGME GAZ 4,2mm	1	1,25 €		
135	JJD00995	THERMOSTAT DE SECURITE	1	3,75 €		
136	JJD71029	TUBE VANNE 3 VOIES/ECHANGEUR	1	50,70 €		
137	JJD00565	TUBE GAZ	1	16,80 €		
140	JJD00565	VANNE GAZ (SIT SIGMA 845063)	1	88,30 €		
147	JJD71029	TRAVERSE PLATINE HYDRAULIQU	1	19,60 €		
150	JJD00541	COUVERCLE	1	1,15 €		
151	JJD00541	COUVERCLE BOITE ELECTRIQUE	1	5,75 €		
152	JJD71040	PANNEAU DE COMMANDE MS BIC	1	29,20 €		
153	JJD00540	COUVERCLE ARRIERE TABLEAU	1	1,00 €		
154	JJD71068	CARTE ELECTRONIQUE	1		JJJ0057024	88,40 €
165	JJD71060	TUBE SORTIE BALLON	1	11,90 €		
166	JJD00568	BARRETTE CONNEXION 5 POLES	1	4,20 €		
169	JJD00570	MANOMETRE D.40 AVEC SUPPORT	1	12,40 €		
174	JJD00062	CLAVIER ELASTOMERE 3 ET 4 BOL	1	3,50 €		
182	JJD71060	TUBE SORTIE ECS - RECIRCULATI	1	14,50 €		
191	JJD00540	JOINT G1/2"	1	1,00 €		
192	JJD00540	JOINT G3/4-17X24X2	1		JJJ0054046	Nous consulter ...
197	JJD00541	JOINT 85,09X5,34 EPDM	1	6,75 €		

MS 24 BIC FF

215	JJD00510	PANNEAU LATERAL FOYER	1	4,55 €		
232	JJD00568	CARTE RELAIS	1	23,60 €		
234	JJD71039	TUBE DISCONNECTEUR MI	1	32,40 €		
236	JJD71087	DISCONNECTEUR+JTS+TUBES MS	1	80,40 €		
239	JJD00540	JOINT LG.250mm	1	1,00 €		
276	JJD00134	CLIP	1	1,00 €		
286	JJD00824	ECROU M5	1	1,00 €		
294	JJD00511	COUVERCLE INFERIEUR	1	41,70 €		
298	JJD00570	PANNEAU ARRIERE CAISSON	1	35,20 €		
300	JJD00540	JOINT LG.235mm	1	1,00 €		
304	JJD00520	SUPPORT NOURRICE	1	2,85 €		
305	JJD00510	PLAQUE VENTILATEUR	1	2,05 €		
336	JJD71004	CLIP FIXATION MOTEUR VANNE 3 \	1	1,40 €		
337	JJD71004	MOTEUR VANNE 3 VOIES MI	1	19,00 €		
340	JJD71004	PRESSOSTAT MANQUE EAU MI	1	21,00 €		
363	JJD71004	JOINT TORIQUE D.17,96X2,62	1	1,00 €		
365	JJD00510	TRAVERSE ARRIERE INFERIEURE	1	4,30 €		
366	JJD00540	JOINT LG.665mm	1	2,05 €		
367	JJD00540	JOINT LG.430mm	1	1,40 €		
369	JJD00540	JOINT LG.205mm	1	1,00 €		
370	JJD00540	JOINT LG.658mm	1	1,75 €		
373	JJD71004	FILTRE CHAUFFAGE	1	1,90 €		
449	JJD00564	CLAPET ANTI-RETOUR DISCONNEI	1	6,50 €		2
511	JJD00540	JOINT TORIQUE D.17,86X2,62 EPDM	1	1,00 €		
528	JJD00843	SONDE DEPART CHAUFFAGE	1	4,30 €		
600	JJD71004	CLIP PLAT D.18MM SOUPAPE	1	1,00 €		
602	JJD71029	CIRCULATEUR GRUNDFOS UPS01!	1	188,00 €		
611	JJD71060	TUBE ENTREE SANITAIRE - RECIR	1	13,30 €		
614	JJD71060	TUBE ENTREE BALLON	1	13,30 €		
622	JJD71039	TUBE DISCONNECTEUR	1	17,90 €		
624	JJD71004	CAPTEUR EFFET HALL	1		JJD710976	12,50 €
673	JJD71029	TUBE SORTIE ECS CIRCUIT BALLO	1	36,20 €		
675	JJD71004	DOUBLE VERROUIL.RESSORT PLA	1	1,90 €		
680	JJD00540	JOINT PASSE-TUBE D.15	1	1,15 €		
763	JJD71004	RESSORT PLAT D.12mm	1	1,00 €		
764	JJD71004	EPINGLE EN U D.3mm	1	1,40 €		
765	JJD71006	JOINT TORIQUE D.9,19X2,62 EPDM	1		JJD710045	1,00 €
766	JJD00511	RESSORT PLAT D.10mm	1	1,00 €		
767	JJD71004	VIS ECHANGEUR A PLAQUES	1	1,00 €		
790	JJD71011	BARRETTE CONNEXION ELECTRIC	1	2,15 €		
794	JJD00511	COUVERCLE SUP. AV/TROU INSPE	1	58,90 €		

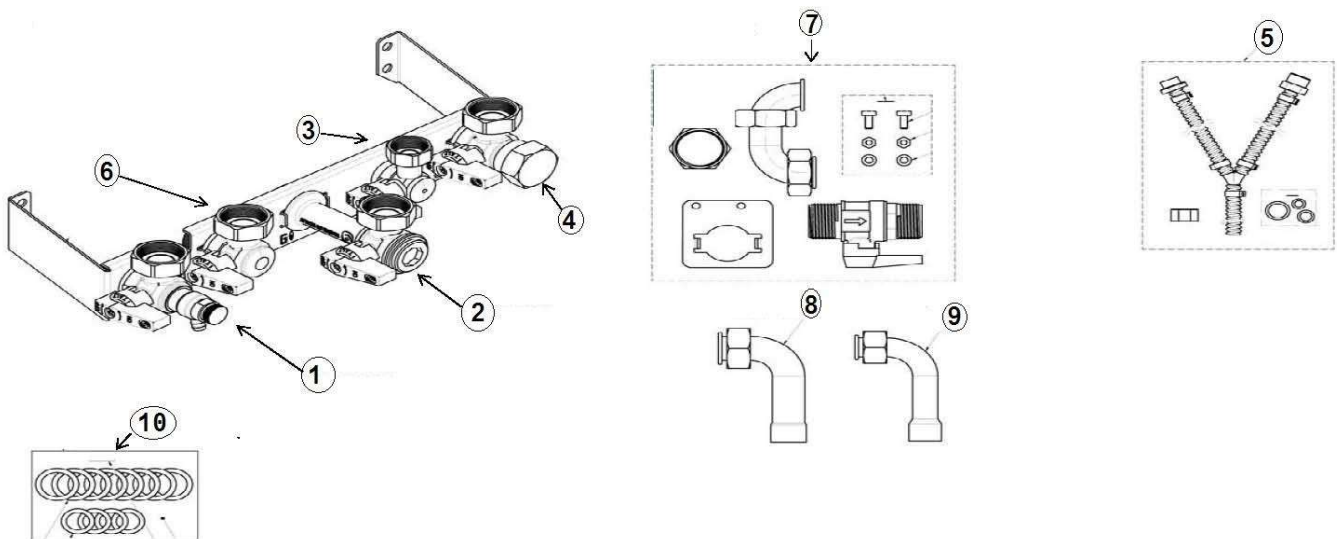

MS 24 BIC FF

Réf.	Référenc	Description	Qté	Tarif	Substitut	Tarif Sub.	Remarques
1	JJD71045	ROBINET DEPART CHAUFFAGE	1	19,50 €			
2	JJD71037	ROBINET GAZ	1	18,80 €			
3	JJD71022	ROBINET ENTREE SANITAIRE G1/2	1	11,50 €			
4	JJD71007	ROBINET RETOUR CHAUFFAGE	1	14,80 €			
5	JJD71046	TUYAU EVACUATION CONDENSAT	1		7647520	18,40 €	
6	JJD71039	ROBINET CHAUFFAGE/BALLON	1	20,80 €			
7	JJD71066	ROBINET EXTERIEUR	1	22,10 €			
8	JJD71040	TUBE D.18mm	1	5,00 €			
9	JJD71040	TUBE D.14mm	1	3,90 €			
10	JJD00363	KIT JOINTS	1	1,60 €			

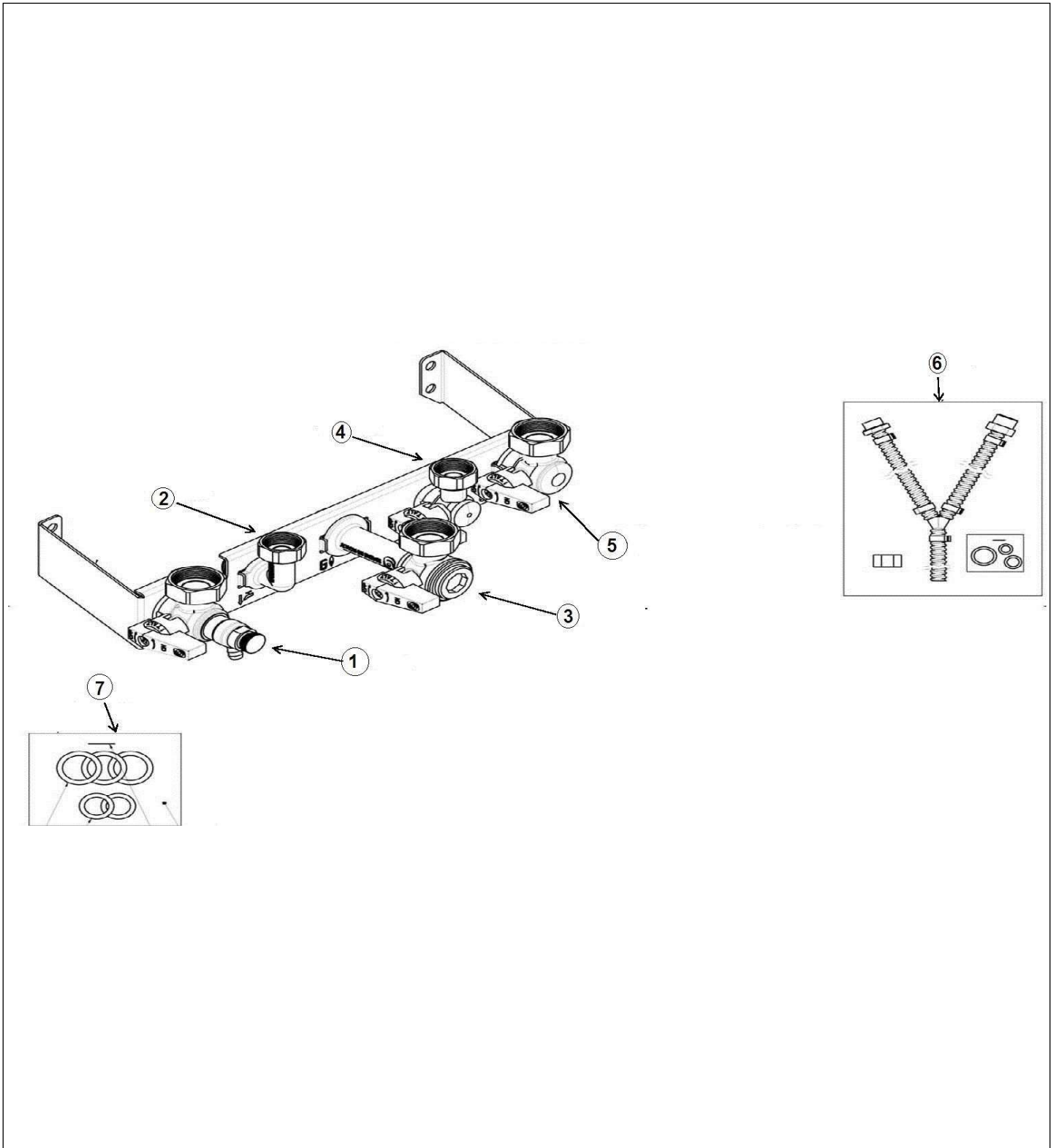

MS 24 BIC FF

Réf.	Référenc	Description	Qté	Tarif	Substitut	Tarif Sub.	Remarques
0	JJJ005210	BOUCHON 3/4"	1	5,10 €			
1	JJD71045	ROBINET DEPART CHAUFFAGE	1	19,50 €			
2	JJD71007	COUDE DEPART ECS	1	5,60 €			
3	JJD71037	ROBINET GAZ	1	18,80 €			
4	JJD71022	ROBINET ENTREE SANITAIRE G1/2	1	11,50 €			
5	JJD71007	ROBINET RETOUR CHAUFFAGE	1	14,80 €			
6	JJD71046	TUYAU EVACUATION CONDENSAT	1		7647520	18,40 €	
7	JJD71035	KIT JOINTS	1	1,00 €			

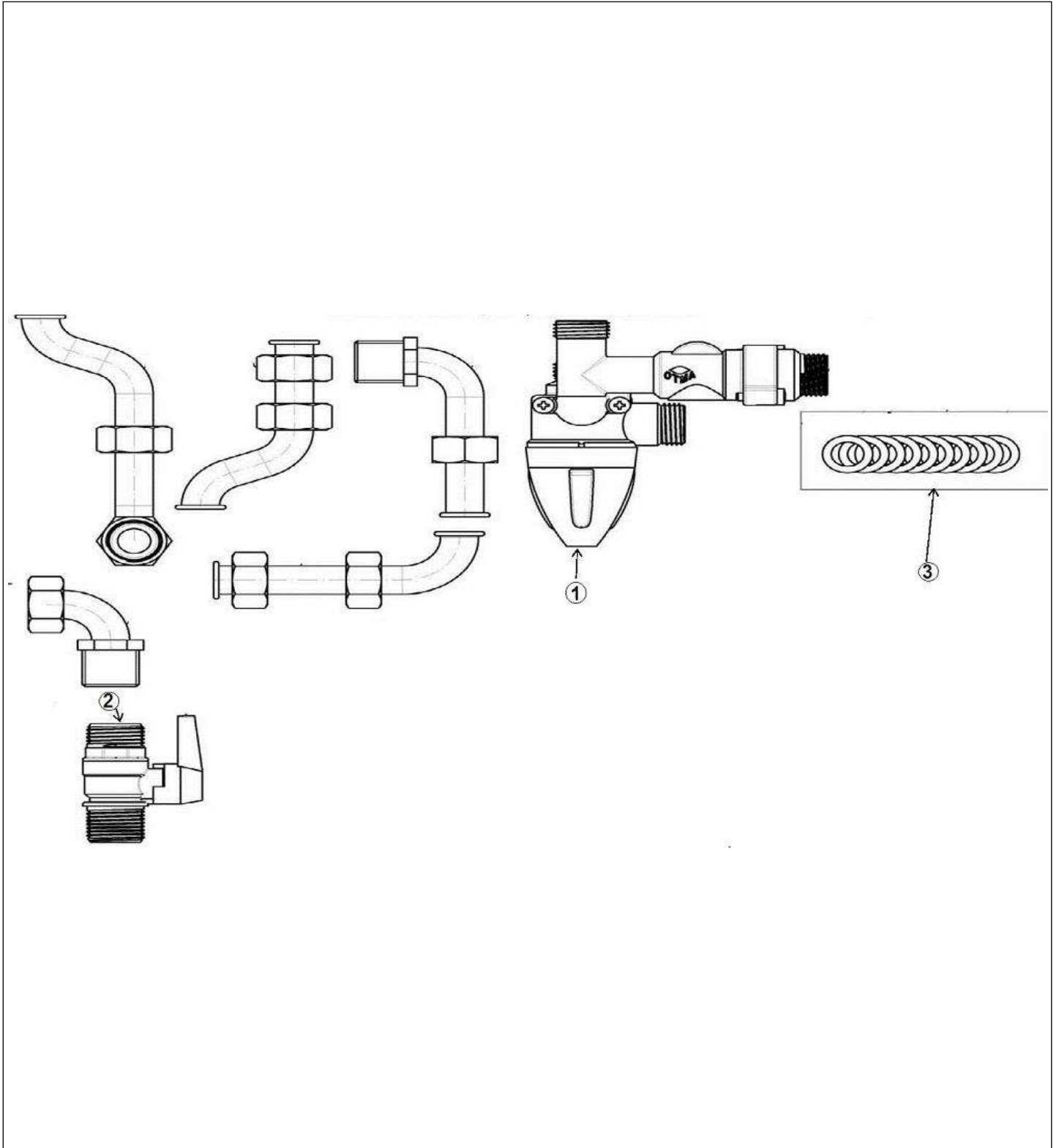

MS 24 BIC FF

Réf.	Référenc	Description	Qté	Tarif	Substitut	Tarif Sub.	Remarques
1	JJD00569	VALVE MITIGEUR	1	164,00 €			
2	JJD00362	ROBINET G1/2"	1	12,50 €			
3	JJD00362	KIT JOINTS	1	1,15 €			

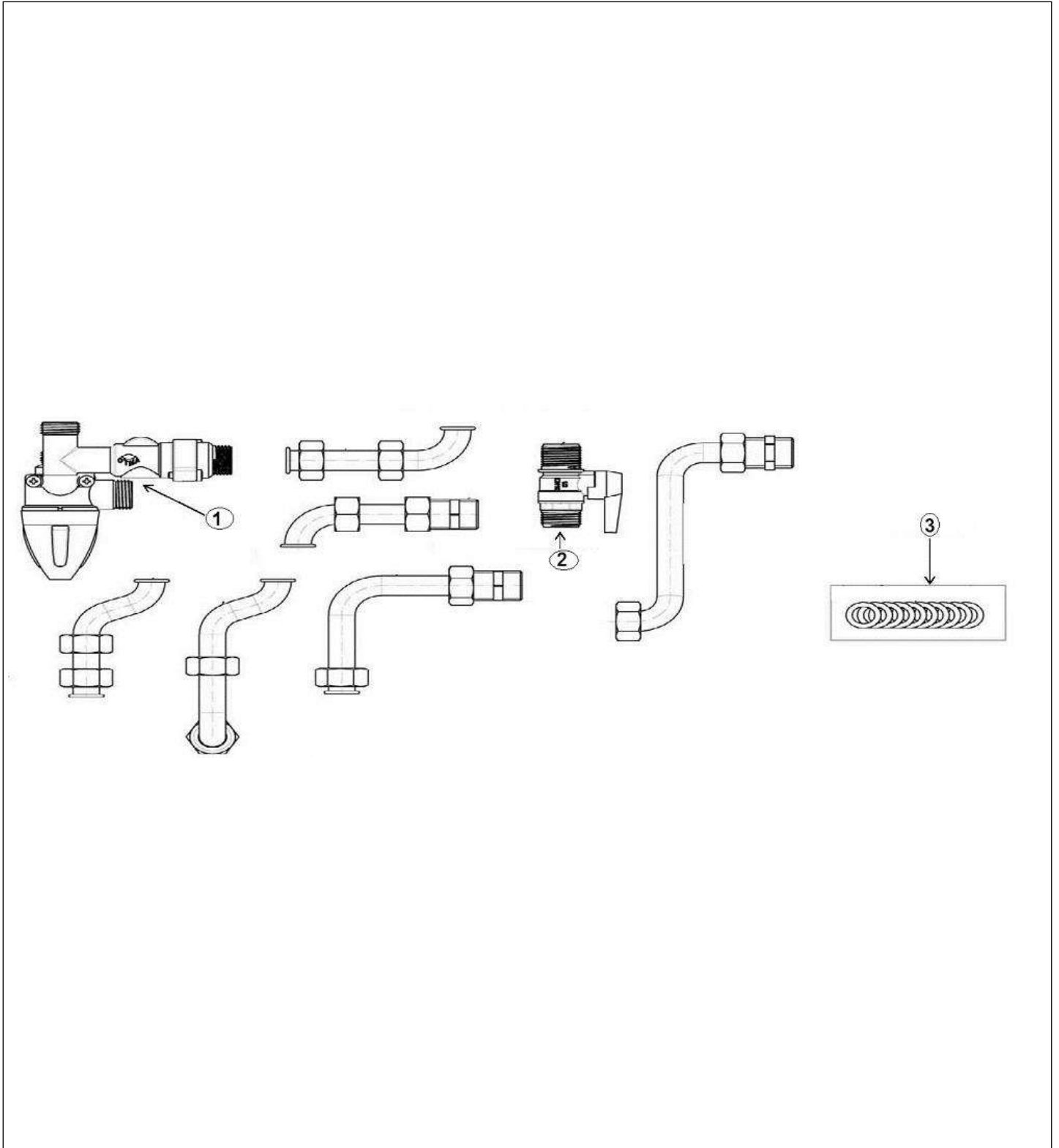

MS 24 BIC FF

Réf.	Référenc	Description	Qté	Tarif	Substitut	Tarif Sub.	Remarques
1	JJD00569	VALVE MITIGEUR	1	164,00 €			
2	JJD00362	ROBINET G1/2"	1	12,50 €			
3	JJD00362	KIT JOINTS	1	1,15 €			

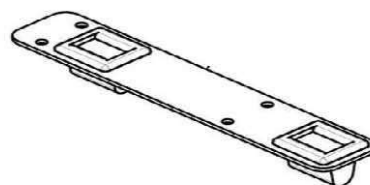
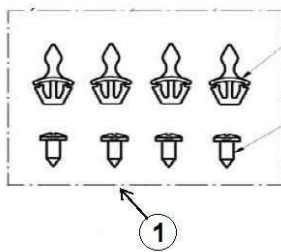
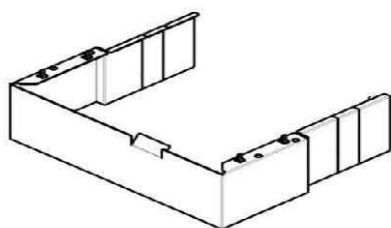

Tab 5

MS 24 BIC FF

Réf.	Référenc	Description	Qté	Tarif	Substitut	Tarif Sub.	Remarques
1	JJD71055	KIT CLIPS	1	1,25 €			